

glit

glider, loopy, take-off

BRALCO



P.02 - take-off

Pag. 42 - 63

P.01 - loopy

Pag. 24 - 41

P.00 - glider

Pag. 6 - 23

glt system

GLT è un sistema per l'arredo d'ufficio sia direzionale che operativo che trae origine dall'unione di 3 serie: Glider - Loopy - Take-Off differenziati dai basamenti ma accumulati dalla stessa componentistica.

GLT is a complete system of office desking designed both executive and operational areas. This collection originates the three independent ranges of Glider, Loopy and Take-Off differentiated by the style of leg but sharing the same components.

GLT est un système pour l'aménagement des bureaux exécutifs et opératifs. C'est l'union de 3 séries: Glider - Loopy - Take-Off différenciées par la forme des piètements mais composées de la même façon.

GLT ist ein Einrichtungssystem sowohl für Büros als auch für Chefzimmer, das aus der Zusammenführung von drei Kollektionen entsteht: Glider - Loopy - Take Off. Bei vielen gemeinsamen Bauteilen unterschieden sich die drei an den Fußgestellen.

GLT is een compleet bureaumeubel systeem welke geschikt is voor zowel de directie als standaard kantoren. Deze collectie biedt 3 afzonderlijke lijnen als Glider, Loopy en Take Off gebruik makende van dezelfde componenten waarbij alleen het pootdesign afwijkt.

GLT es un sistema de mobiliario para la oficina direccional y operativo que tiene su origen de la union de 3 series: Glider - Loopy - Take-Off diferenciadas por sus estructuras de sustentacion pero unidas por los mismos componentes.

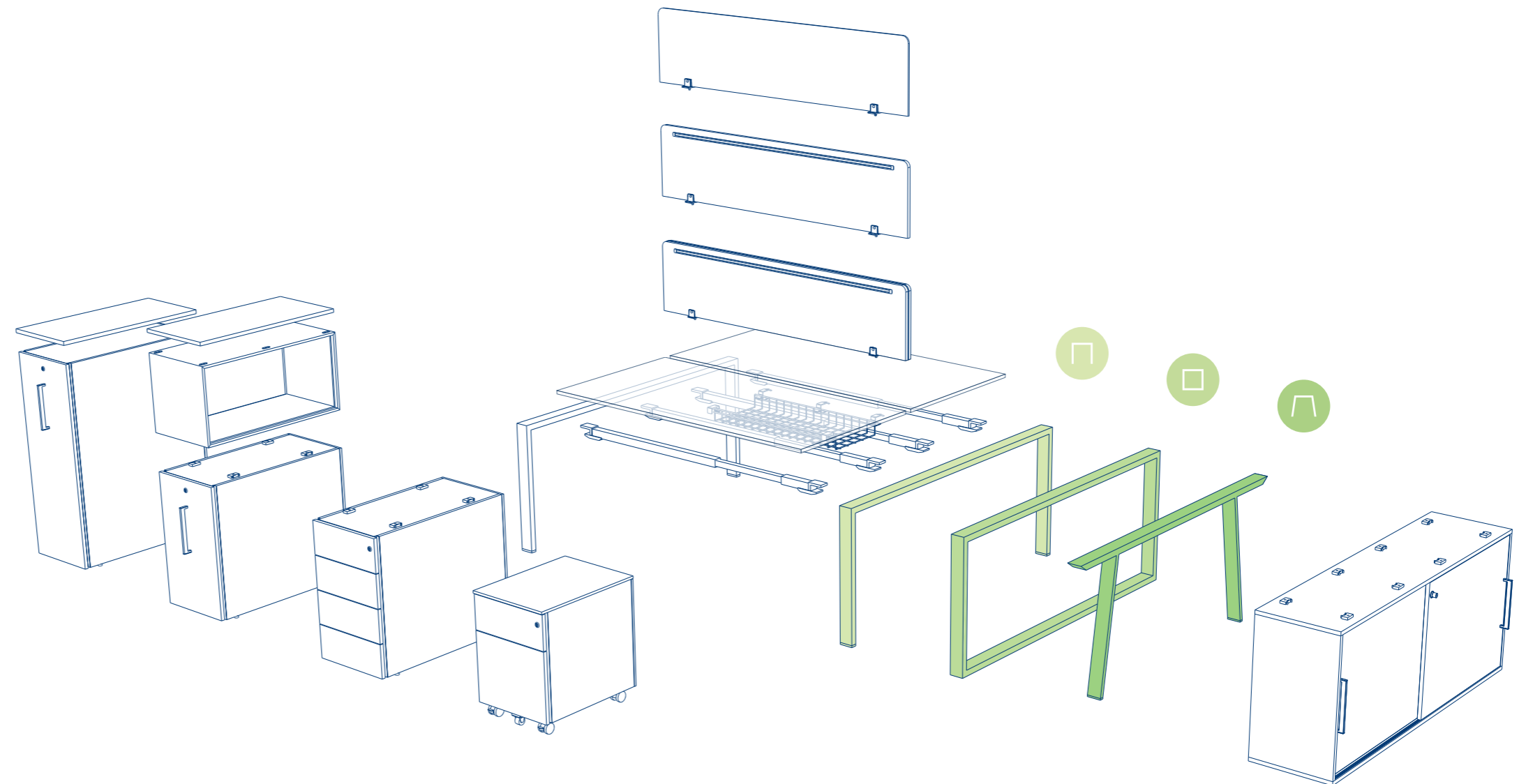



Glider è un programma flessibile con spiccate caratteristiche di trasformazione delle soluzioni Direzionale / Operativo / Home office e con possibilità di adattarsi alle esigenze del singolo o del lavoro di gruppo.

Glider is a flexible range of desking complete with an easy transformation of characteristics to enhance Executive, Operative or Home office solution and with the endless possibilities of adapting the system to each clients requirements and needs.

Glider est un programme flexible avec de fortes caractéristiques de transformation avec des solutions Executive / Operative / Home Office et avec la possibilité de s'adapter aux exigences individuelles ou d'équipes.

Glider ist ein besonders verwandlungsfähiges, flexibles System, das sich mühelos in jede Umgebung, Chefzimmer / Standardarbeitsplatz / Heimbüro, als Einzel- oder Gruppenarbeitsplatz, einfügen lässt.

Glider is een flexibele bureaulijn met een eenvoudige transformatie naar een standaard, luxe of huiselijke uitstraling met eindeloze aanpassingsmogelijkheden welke conform de configuratie eisen en behoeften van de opdrachtgever zijn.

Glider es un programa flexible con notables características de transformación de las soluciones direccional / operativo / home office y con posibilidad de adaptarse a las exigencias de cada uno o del trabajo conjunto.

glider



Front Office

Front Office, Front Office, Empfangsbüro, Front Office, Front Office.





Ampia gamma di finiture proposte oltre alle tradizionali, nuovi piani ricercati di design in vetroceramica

A wide range of finishes available from traditional – contemporary. New desk height design in ceramic glass

Large gamme de finitions proposées ajoutées aux traditionnelles, plateaux avec un nouveau design disponibles en vitrocéramique

Zu der traditionell reichhaltigen Auswahl an Oberflächen kommen nun attraktive Designarbeitsplatten aus Glaskeramik.

Uitgebreide afwerkingsmogelijkheden beschikbaar van traditioneel tot eigentijds. Nieuw bureaudeSIGN in keramiek glas.

Amplia gama de acabados propuestos además de los tradicionales, nuevos planos cotizados de design en vitroceramica

Operative

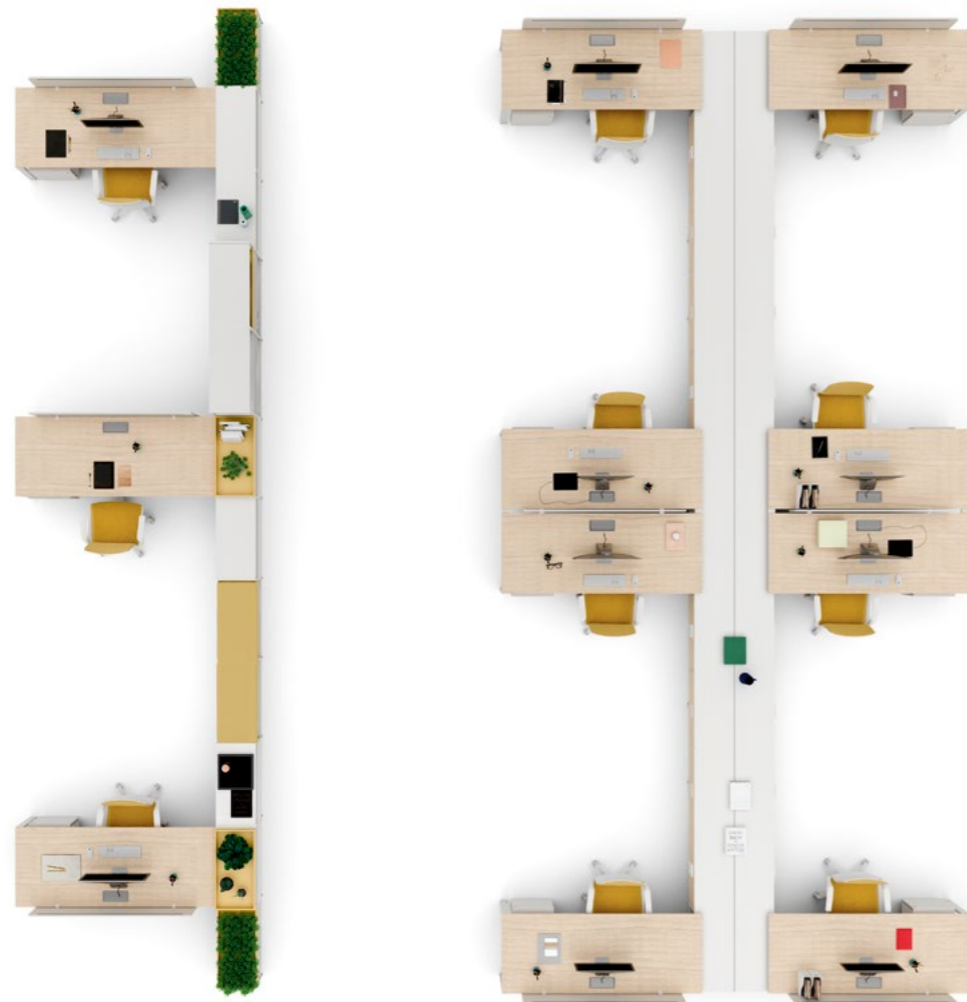

Minimalismo contraddistinto da numerose tipologie di elementi

Minimalism featured by numerous kinds of elements.
Minimalisme distingué par de nombreuses typologies d'éléments.
Minimalistisch aber reich an Elementen und Varianten.
Minimalisme gekenmerkt door talrijke soorten elementen.
Minimalismo marcado de numerosos tipos de elementos.





Si definiscono spazi di lavoro con un nuovo concetto di archiviazione modulare.

Work spaces are defined with a new concept of modular storage.

Les espaces de travail sont définis avec un nouveau concept de rangement modulaire.

Arbeitsflächen lassen sich durch ein neu konzipiertes modulares Ablagemodell gliedern.

Werkgebieden worden mogelijk gemaakt door een nieuw concept modulaire opbergkasten.

Se definen espacios de trabajo con nuevo concepto de archivo modular.





Executive





**Glider: non solo Operativo ma anche Direzionale
per una linea di arredo trasversale
Gamma di finiture: dal legno impiallacciato
al melaminico ai vetri.**

Glider: not only operative but also executive
for a transversal furniture range
Range of finishes: from wood veneered
to melamine and glass.

Glider: non seulement opératif mais aussi direction
pour une gamme d'aménagement transversale
Gamme de finitions : placage bois,
mélamine et verre.

Glider: eine einige Kollektion vom
Standardarbeitsplatz bis zum Chefzimmer durchziehen
Oberflächenauswahl: von Melamin über Holzfurnier
bis hin zu Glasvariationen.

Glider: niet alleen als een standaard meubel
maar ook toepasbaar als directie model
Materiaalmogelijkheden: zowel houtfineer
als melamine en glas.

Glider: no solo operativo sino direccional
con posibilidades de composiciones transversales
con apoyos en muebles de servicio.
Gama de acabados: de madera contrachapada
a melamina y vidrios.

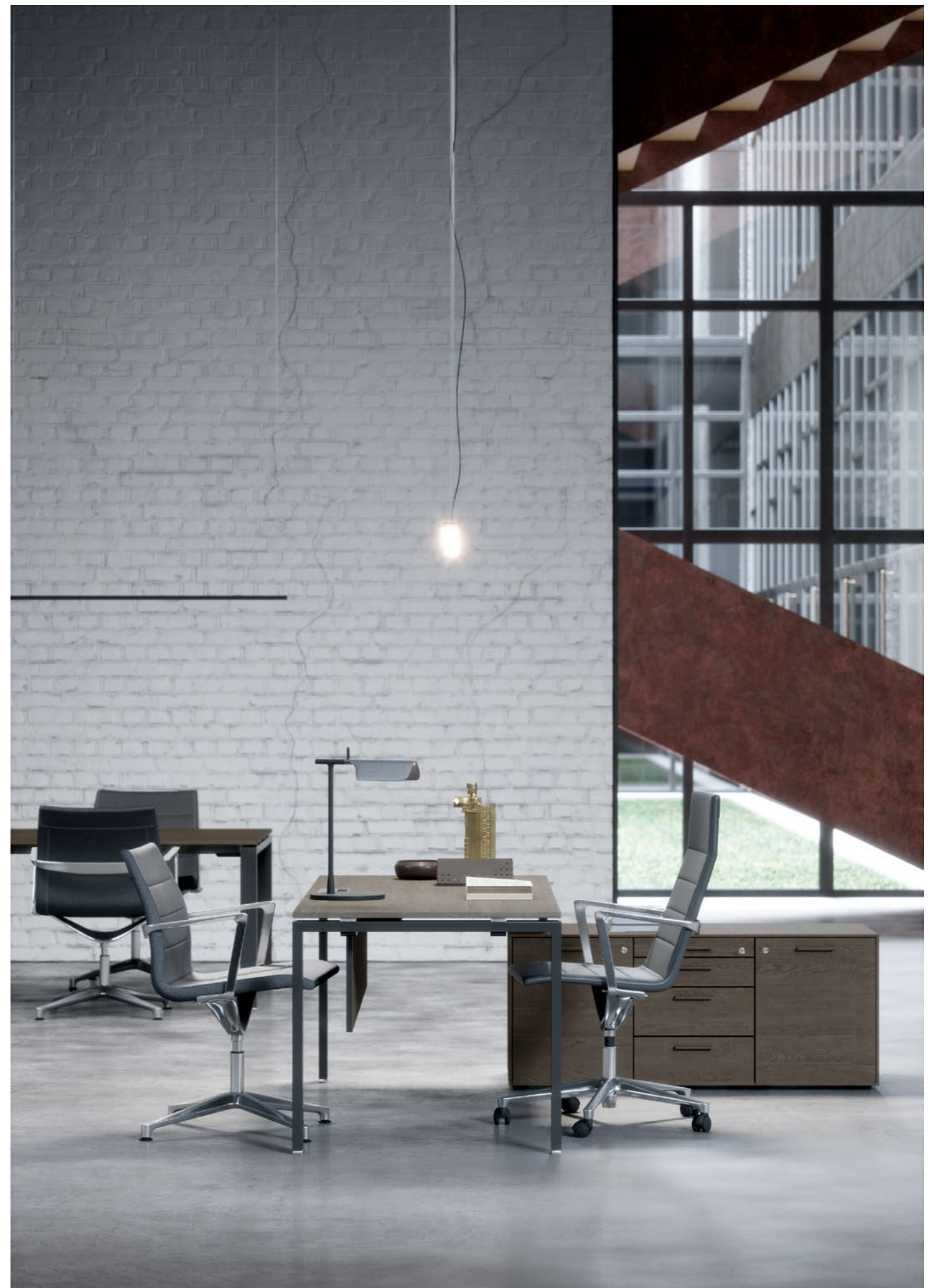

Alcuni esempi di possibili configurazioni

Some examples of possible layouts - Voici quelques exemples de configurations possibles - Einige Beispiele von möglichen Konfigurationen - Een aantal voorbeelden van mogelijke configuraties - Algunos ejemplos de configuraciones posibles

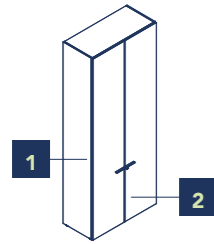

100x46 cm
h. 272 cm

Pag. 8,9

Armadio ABA, Cabinet ABA, Armoire ABA, Schrank ABA, Kast ABA, Armario ABA.

1 MK
2 WW

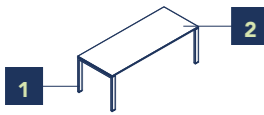

200x80 cm
h. 72 cm

Pag. 7,8,9,10,11

Scrivania, Desk, Bureau, Schreibtisch, Bureau, Escritorios.

1 NF
2 EG

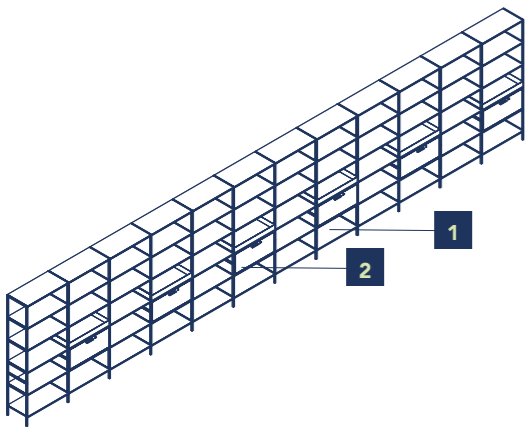

986x41 cm
h. 214 cm

Pag. 14,15,16,17

Mobile Concerto, Cabinet Concerto, Meuble Concerto, Möbel Concerto, Meubel Concerto, Mueble Concerto.

1 BW
2 LJ

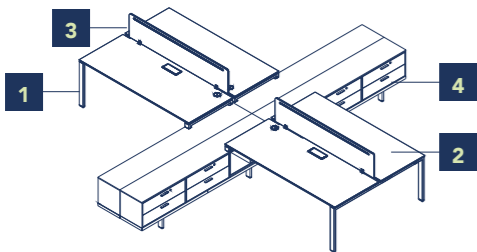

482x246 cm
h. 110 cm

Pag. 12,13,15,16,17

Bench a ponte su mobile Ubi + schermo per scrivania
Bench on cabinet Ubi + screen for desk, Bench pont sur meuble Ubi + Ecran privatif pour bureau, Bench auf möbel Ubi + Sichtschutz, Bench op meubel Ubi + Bureauscherm, Bench puente an mueble Ubi + Pantalla para escritorio.

1 BW
2 RN
3 BL
4 RN

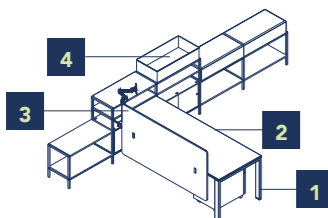

412x240 cm
h. 110 cm

Pag. 12,13

Scrivania con mobile concerto + schermo per scrivania
Desk with cabinet Concerto + screen for desk, Bureau avec meuble Concerto + Ecran privatif pour bureau, Schreibtisch mit möbel Concerto + Sichtschutz, Bureau met meubel Concerto + Bureauscherm, Escritorio con mueble Concerto + Pantalla para escritorio.

1 BW
2 RN
3 BL
4 LJ

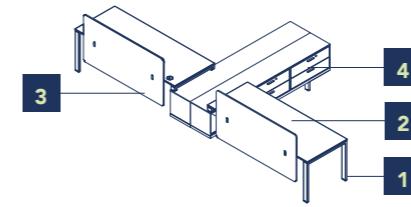

240x246 cm
h. 110 cm

Pag. 12,13,15,16,17

Scrivania a ponte su mobile Ubi + schermo per scrivania
Bridge desk on cabinet Ubi + screen for desk, Bureau pont sur meuble Ubi + Ecran privatif pour bureau, Schreibtisch-Brücke auf möbel Ubi + Sichtschutz, Brugtafel op meubel Ubi + Bureauscherm, Escritorio puente an mueble Ubi + Pantalla para escritorio.

1 BW
2 RN
3 BL
4 LJ



120x800 cm
h. 111 cm

Pag. 15,16,17

Mobile Ubi con top, Cabinet Ubi with top, Meuble Ubi avec top, Möbel Ubi mit abdeckplatten, Meubel Ubi met topbladen, Mueble Ubi con partes superiores.

1 BL
2 LJ
3 BL



120x60 cm
h. 38 cm

Pag. 18,19,20

Tavolino, Small table, Petit table, kleinertisch, kleine tafel, Mesa.

1 GF
2 RG

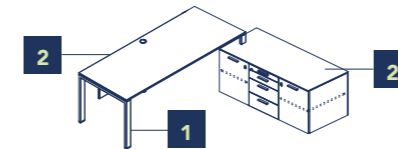

228x184 cm
h. 72 cm

Pag. 18,19,20,21

Scrivania con gamba zoppa su mobile di servizio, Desk with shortened leg on service cabinet, Bureau avec piétement sur meuble de service, Schreibtisch mit verkürztem Bein auf Werkboxmodul, Bureau met manke poot op dienstmeubel, Escritorio con pata coja en mueble de servicio.

1 GF
2 RG

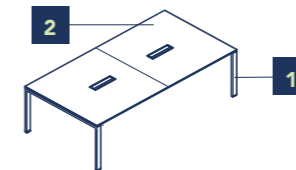

240x124 cm
h. 72 cm

Pag. 18,19,20,21

Tavolo riunione, Meeting table (8 places), Table reunion (8 places), Besprechungstisch (8 personen), Wergadertafel (8 plaatsen), Mesa reunión (8 puestos).

1 GF
2 RG

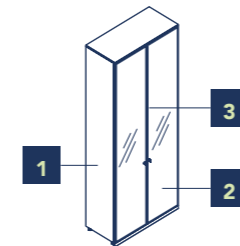

100x46 cm
h. 272 cm

Pag. 18,19,20

Armadio ABA, Cabinet ABA, Armoire ABA, Schrank ABA, Kast ABA, Armario ABA.

1 MK
2 VG
3 NF

Per una più completa visione della collezione, consultare il listino

To view the collection in more detail, Please refer to our price list - Pour un meilleur aperçu de la collection, veuillez consulter la liste des prix - Eine komplette Ansicht der Kollektion finden Sie in der Preisliste - Om de volledige collectie te raadplegen, zie de lijst - Para ver más detalladamente la colección, consultar la tarifa.



Programma flessibile che si estende dal direzionale di prestigio agli operativi. La base ad angolo chiuso garantisce un aspetto elegante con un minimalismo delle forme.

Flexible program that extends from prestigious executive to operative. The closed angle leg guarantees an elegant appearance with minimalist shapes.

Programme flexible qui s'étend des bureaux de direction prestigieux aux opératifs. Le piétement fermé garanti une apparence élégante avec des formes minimalistes.

Ein flexibles Programm, vom edlen Chefszimmer bis zum Standardarbeitsplatz. Das Kufen-Seitengestell ist eine gelungene Verbindung von Minimalismus und Eleganz.

Flexibel programma reikend van prestigieuze luxe tot standaard modellen. De gesloten hoekpoot garandeert een elegante verschijning met minimale vormen.

Programa flexible que abarca del direccional de prestigio a los operativos. La base a angulo cerrado garantiza un aspecto elegante con un minimalismo de las formas.

loopy



Operative



**UBI ed armadi ad ante a scorrere:
accostamento di elementi
per l'organizzazione
e l'archiviazione in ufficio.**

UBI and sliding doors cabinets:
combination of elements
for organization and filing in the office.

UBI et armoires avec portes coulissantes:
combinaison d'éléments
pour l'organisation et le classement au bureau.

UBI und Schiebetürenschränke:
Elementkombinationen
für Organisation und Ablage im Büro.

UBI en schuifdeurkasten:
diverse element mogelijkheden
voor georganiseerd opbergen en archiveren
binnen het kantoor.

UBI y armarios con puertas correderas:
combinacion de elementos
para la organizacion y el archivo en la oficina.





Kubick



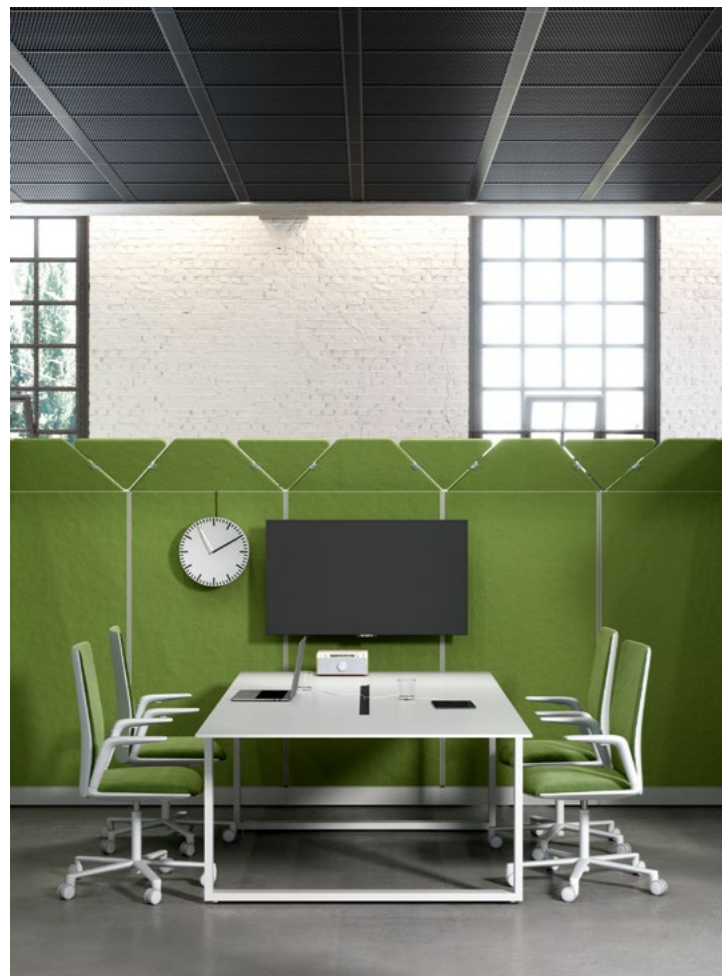

**Isole di lavoro nel rispetto della Privacy.
Spazi aperti ma protetti
acusticamente e accessoriabili.**

Islands of work in respect of privacy.
Open spaces with added acoustic features and accessible.

Ilots de travail dans le respect de la confidentialité.
Espaces ouverts mais protégés acoustiquement
et accessorisés.

Arbeitsinsel, die trotzdem eine Privatsphäre ermöglichen.
Offene Räume, die trotzdem akustischen Schutz und viel
Accessoires bieten.

Werkeilanden met privacy.
Open ruimtes met toegankelijke akoestische elementen.

Isla de trabajo que respeta la privacidad.
Espacios abiertos pero protegidos
acusticamente y con accesorios.



Executive





Spazi Riunioni: gamma completa di tavoli riunioni e complementi per esigenze sempre più richieste sia negli ambienti Direzionali che Operativi.

Meeting Spaces: full range of meeting tables and accessories for increasing demands in both Executive and Operational situations.

Espaces pour réunions : une gamme complète de tables de réunion et de compléments pour répondre aux exigences de plus en plus importantes dans des contextes Direction et Opératifs.

Besprechungsbereiche: eine reichhaltige Palette an Besprechungstischen und Zubehör werden jedem Anspruch gerecht, auch in den Chefetagen.

Vergaderruimtes: volledige serie van vergadertafels en accessoires geschikt voor zowel de directie als standaard situaties.

Espacios de reuniones: gama completa de mesas para reuniones y complementos en los ambientes direccionales y operativos.



Alcuni esempi di possibili configurazioni

Some examples of possible layouts - Voici quelques exemples de configurations possibles - Einige Beispiele von möglichen Konfigurationen - Een aantal voorbeelden van mogelijke configuraties - Algunos ejemplos de configuraciones posibles

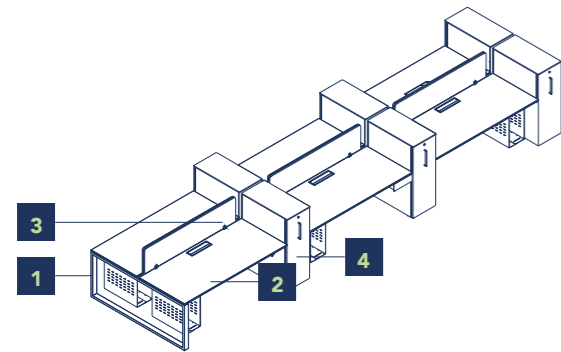

660x164 cm
h. 111 cm

Pag. 28,29,30,31

Bench con vertical files h.111 cm + schermo scrivania, Bench with vertical files h.111 cm + screen for desk, Bench avec classeurs verticaux h.111 cm + Ecran privatif pour bureau, Bench mit vertical file h.111 cm + Sichtschutz, Bench met hangmappen h.111 cm + Bureauscherm, Bench con archivadores verticales h.111 cm. + Pantalla para escritorio.

- 1 BW
- 2 BL
- 3 VG
- 4 BL

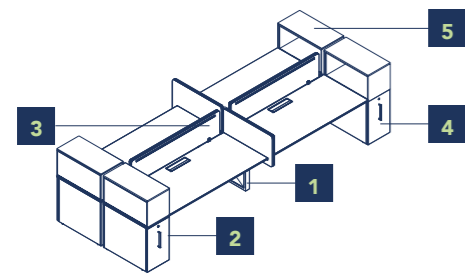

440x164 cm
h. 111 cm

Pag. 26,27,29,30,31

Bench con vertical files h.69 cm e Ubi + schermo scrivania, Bench with vertical files h.69 cm and Ubi + screen for desk, Bench avec classeurs verticaux h.69 cm et Ubi + Ecran privatif pour bureau, Bench mit vertical file h.69 cm und Ubi + Sichtschutz, Bench met hangmappen h.69 cm en Ubi + Bureauscherm, Bench con archivadores verticales h.69 cm. y Ubi + Pantalla para escritorio.

- 1 BW
- 2 BL
- 3 PV
- 4 BL
- 5 LF

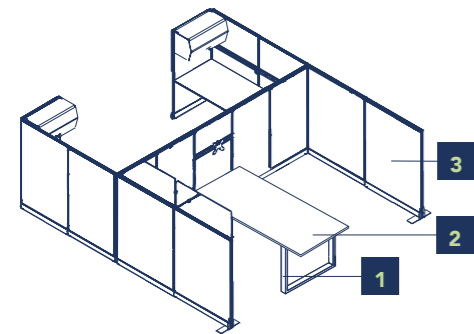

408x448 cm
h. 186 cm

Pag. 32,33,34

Tavolo riunione + Kubick, Meeting table + Kubick, Table reunion + Kubick, Besprechungstisch + Kubick, Wergadertafel + Kubick, Mesa reunión + Kubick.

- 1 BW
- 2 BL
- 3 Y3

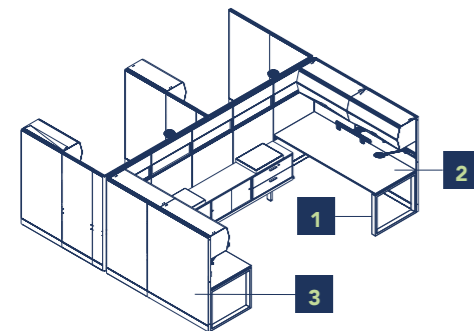

412x364 cm
h. 162 cm

Pag. 32,34,35

Scrivania + Kubick, Desk+ Kubick, Bureau + Kubick, Schreibtische + Kubick, Bureau+ Kubick, Escritorios + Kubick.

- 1 BW
- 2 BL
- 2 Y3

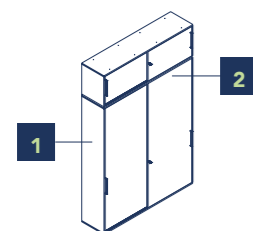

160x46 cm
h. 249 cm

Pag. 28,30,31

Armadio asl, Cabinet asl, Armoire asl, Schrank asl, Kast asl, Armario asl.

- 1 BL
- 2 BL

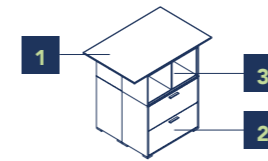

120x80 cm
h. 111 cm

Pag. 28,30,31

Mobile Ubi con top, Cabinet Ubi with top, Meuble Ubi avec top, Möbel Ubi mit abdeckplatten, Meubel Ubi met topbladen, Mueble Ubi con partes superiores.

- 1 BL
- 2 BL
- 3 LF



ø 80 cm
h. 73÷109 cm

Pag. 32,33,34

Tavolo altezza regolabile, Height adjustable table, Table réglable en hauteur, Höhe verstellbaren Tisch, Hootge verstelbare tafel, Mesa regulable en altura.

- 1 KR
- 2 RR

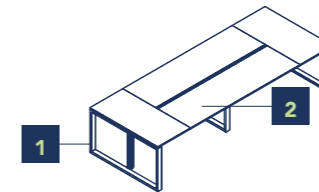

320x124 cm
h. 72 cm

Pag. 36,37,38

Tavolo riunione (10+14 posti), Meeting table (10+14 places), Table reunion (10+14 places), Besprechungstisch (10+14 personen), Wergadertafel (10+14 plaatsen), Mesa reunión (10+14 puestos).

- 1 KR
- 2 RR

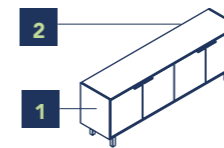

203x46 cm
h. 72 cm

Pag. 36,37,38

Credenze, Storage units, Desserte, Beistellmöbel, Dressoir, Aparador.

- 1 KR
- 2 RR

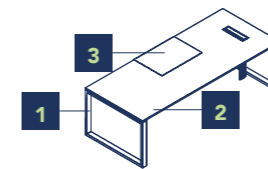

240x100 cm
h. 72 cm

Pag. 36,37,39

Scrivania, Desk, Bureau, Schreibtische, Bureau, Escritorios.

- 1 KR
- 2 RR

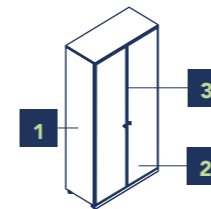

100x46 cm
h. 272 cm

Pag. 36,39

Armadio con ante in vetro, Cabinet with glass doors, Armoire avec vantaux en verre, Schrank mit glastüren, Kast met glazen duren, Armario con puertas de cristal.

- 1 MK
- 2 CN
- 3 KR

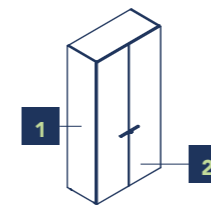

100x46 cm
h. 272 cm

Pag. 36,39

Armadio, Cabinet, Armoire, Schrank, Kast, Armario

- 1 MK
- 2 RR

Per una più completa visione della collezione, consultare il listino

To view the collection in more detail, Please refer to our price list - Pour un meilleur aperçu de la collection, veuillez consulter la liste des prix - Eine komplette Ansicht der Kollektion finden Sie in der Preisliste - Om de volledige collectie te raadplegen, zie de lijst - Para ver más detalladamente la colección, consultar la tarifa



Un basamento trendy contraddistingue la linea Take-Off. Non solo Direzionali ed Operativi ma anche strutture per molteplici usi.

A trendy leg shape distinguishes the Take-Off range. Not only Directional and Operative but also options for bench and multi-user configurations.

Un piètement moderne distingue la gamme Take off. Pas seulement des bureaux Direction et Opératif mais aussi des structures pour des usages multiples.

Ein modisches Fußgestell ist das Identifikationsmerkmal der Kollektion Take-Off. Es lässt sich für viel mehr als nur für Chef- und Standardarbeitsplätze einsetzen.

De Take Off sersie onderscheid zich door een trendy pootdesign. Niet alleen geschikt voor luxe of standard opstellingen maar ook voor benches en meervoudige configuraties.

Una base trendy es contraseña de la linea Take-Off. No solo son utilizables para puestos direccionales y operativos sino tambien para multiples usos.

take-off

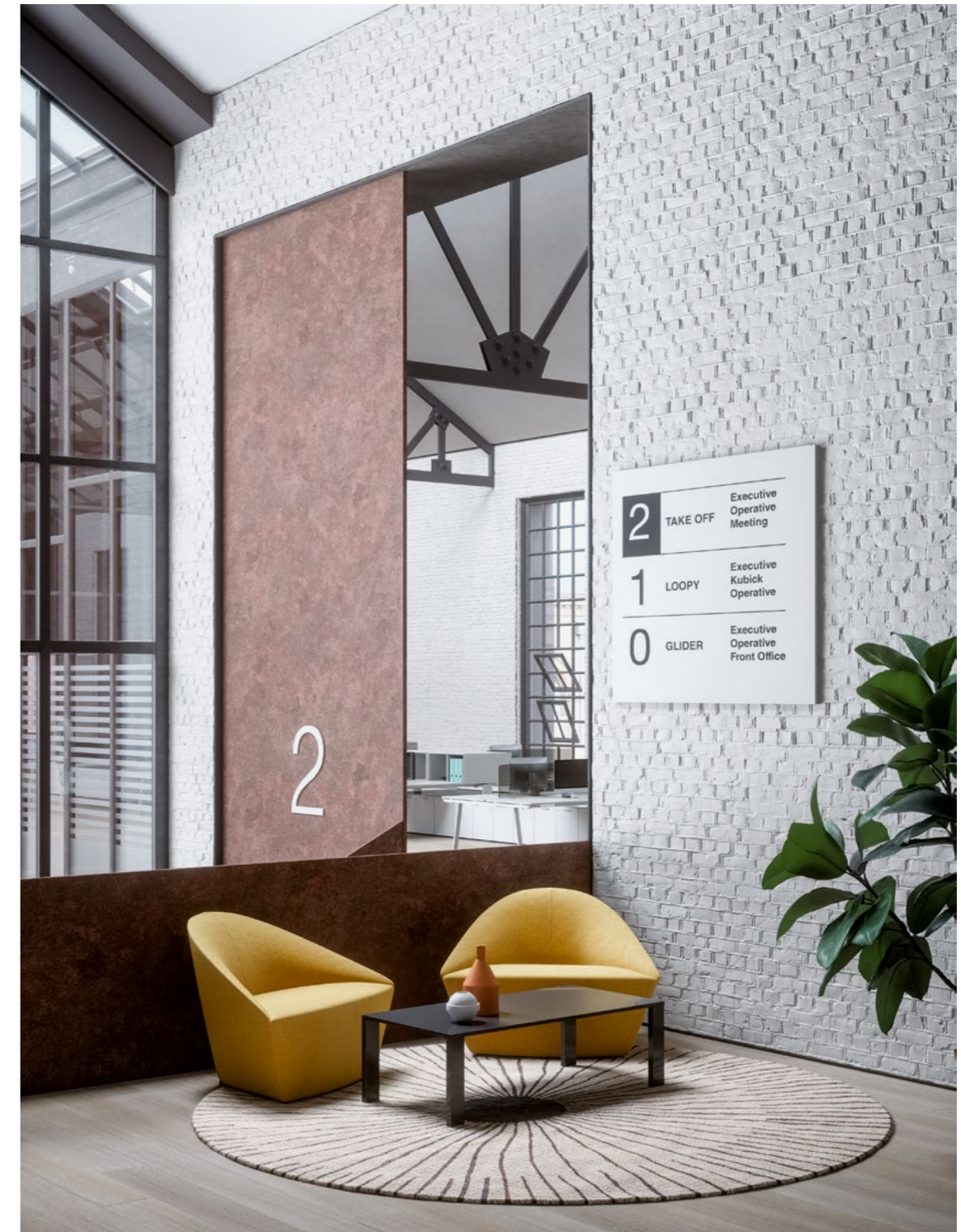

Meeting





**Tavoli con H.90 e 105 per meeting
o momenti di aggregazione.
Disponibilità di finiture,
dimensioni ed accessori.**

Tables 90 and 105 high for meetings or aggregation moments. Availability of finishes, dimensions and accessories.

Tables H. 90 et 105 cm pour réunions ou moments de détente. De nombreuses finitions, dimensions et accessoires sont disponibles.

Tische mit Höhe 90 bzw. 105 cm bieten sich für Meetings oder Pausentreffs an. Mit reichhaltiger Auswahl an Oberflächen, Größen und Zubehör.

Statafels 90 and 105 hoog voor overleg of informele momenten. Diverse materialen, afmetingen en accessoires beschikbaar.

Mesas con h. 90 y 105 para meeting o reuniones cortas. Disponibilidad de acabados, dimensiones y accesorios.

Operative



L'uso degli elementi modulari UBI offre una grande flessibilità dello spazio. Modularità e gamma di colori per infinite soluzioni cromatiche personalizzate.

Using the UBI modular elements for great space flexibility. Modularity and colors for infinite color solutions.

L'utilisation d'éléments modulaires UBI pour une grande flexibilité d'espace. Modularité et couleurs pour des solutions colorées et personnalisées.

Die Verwendung der UBI-Module ermöglicht eine ungeahnte Freiheit bei der Raumgestaltung. Die individuellen Lösungen sind dank Modul- und Farbauswahl grenzenlos.

Het gebruik van UBI modulaire elementen creëert ruimtelijke flexibiliteit. Modulair en kleuren voor eindeloze kleurvarianties.

El uso de los elementos modulares UBI da gran flexibilidad al espacio y la modularidad y gama de colores para infinitas soluciones cromáticas personalizadas.





Executive





Armadiature H.280 cm. e moduli di servizio affiancati al posto di lavoro per un Direzionale di Design.

Cabinets H.280 cm and service modules next to the workstation for a high design Executive solution.

Armoires H.280 cm. et modules de service à côté du poste de travail pour des espaces direction modernes.

Schränke mit durchgehender Höhe bis 280 cm, sowie Sideboards direkt am Arbeitsplatz zeichnen ein Designchefzimmer aus.

Kasten 280cm hoog en service elementen naast de werkplek voor een exclusieve vormgegeven oplossing.

Armarios h. 280 cm. y modulos de servicios envuelven a los puestos direccionales de diseño.





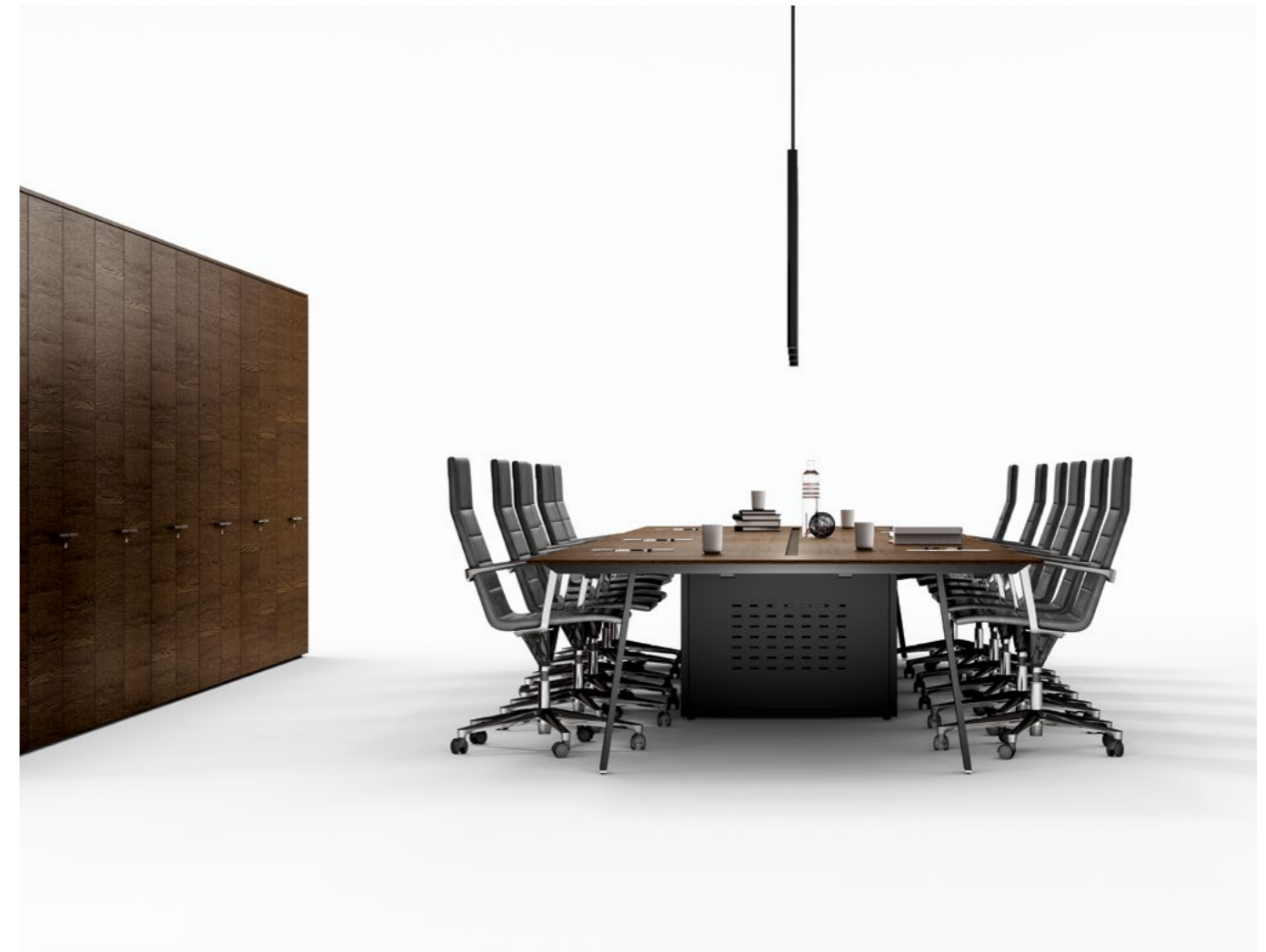

**Lo spazio riunione per esprimere idee con stile ed efficacia.
Finiture dei piani e strutture metalliche per aggiungere un tocco di classe all'immagine aziendale.**

The meeting area for expressing ideas is recognised by style and effectiveness. Special finishes for the tops and metallic structures to add a touch of class to the company image.

L'espace de réunion exprime les idées avec style et efficacité. Les finitions des plateaux et des structures métalliques ajoutent une touche de classe à l'image de l'entreprise.

Der Bereich für die Zusammenkunft, um Ideen mit Stil und Wirkungskraft vorzubringen. Die Finish-Ausführungen der Platten und die Metallstrukturen bereichern das Image des Unternehmens um einen Hauch von Klasse.

De vergaderruimte om met stijl en werkzaamheid ideeën uit te drukken. Afwerking van de vlakken en metalen structuren om een beetje klasse aan het beeld van de firma toe te voegen.

El espacio de reunión para expresar ideas con estilo y efectividad. Acabados de los planos y estructuras metálicas para añadir un toque de estilo a la imagen de la empresa.

Alcuni esempi di possibili configurazioni

Some examples of possible layouts - Voici quelques exemples de configurations possibles - Einige Beispiele von möglichen Konfigurationen - Een aantal voorbeelden van mogelijke configuraties - Algunos ejemplos de configuraciones posibles

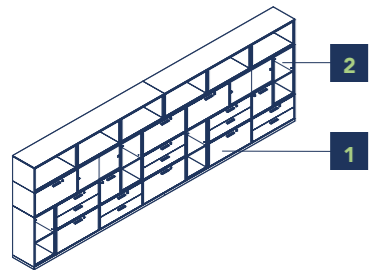

482x40 cm
h. 166 cm

Pag. 44,45,48,49,52

Mobile Ubi, Cabinet Ubi, Meuble Ubi, Möbel Ubi, Meubel Ubi, Mueble Ubi.

1 BL

2 L5

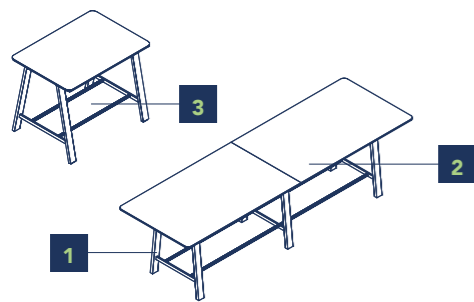

200x100 cm
h. 105 cm

400x124 cm
h. 105 cm

Pag. 44,45,46,47

Tavolo take off evo, Desk take-off evo, Bureau take off evo, Schreibtische take off evo, Bureau take off evo, Escritorios take off evo.

1 NF

2 BL

3 NF

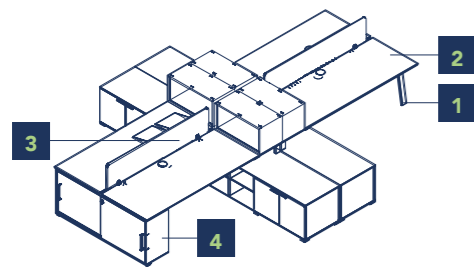

480x334 cm
h. 110 cm

Pag. 50,51,52,53

Bench a ponte su mobile Ubi + armadi scorrevoli, Bench on cabinet Ubi + Cabinets with sliding doors, Bench pont sur meuble Ubi + Armoires avec portes coulissantes, Bench auf möbel Ubi + Schranke mit Schiebetüren, Sichtschutz, Bench op meubel Ubi + Kasten met schuifdeuren, Bench puente an mueble Ubi + Armarios con puertas correderas.

1 BW

2 BL

3 VG

4 BL

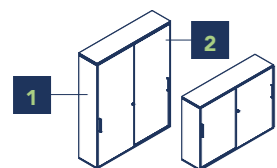

160x46 cm
h. 195 cm

160x46 cm
h. 119 cm

Pag. 44,45,46,47,48,51

Armadio asl, Cabinet asl, Armoire asl, Schrank asl, Kast asl, Armario asl.

1 BL

2 BL

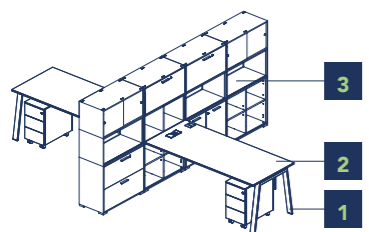

321x400 cm
h. 150 cm

Pag. 48,49

Scrivania con mobile Ubi, Desk with cabinet Ubi, Bureau avec meuble Ubi, Schreibtisch mit möbel Ubi, Bureau met meubel Ubi, Escritorio con mueble Ubi.

1 BW

2 BL

3 L5

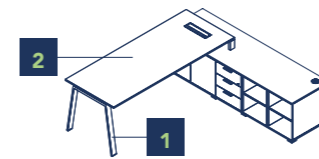

228x210 cm
h. 72 cm

Pag. 54,55,56,57

Scrivania a ponte su mobile di servizio, Bridge desk on service cabinet, Bureau pont sur meuble de service, Schreibtisch-Brücke auf Werkboxmodul, Brugtafel op dienstmeubel, Escritorio puente en mueble de servicio.

1 NF

2 RT

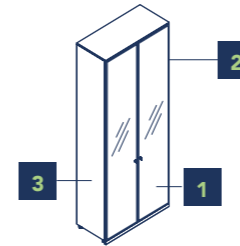

100x46 cm
h. 272 cm

Pag. 54,55,56,57

Armadio ABA, Cabinet ABA, Armoire ABA, Schrank ABA, Kast ABA, Armario ABA

1 VG

2 NF

3 MK



60x60 cm
h. 38 cm

Pag. 54,55

Tavolino, Small table, Petit table, kleinertisch, kleine tafel, Mesa.

1 NF

2 RT

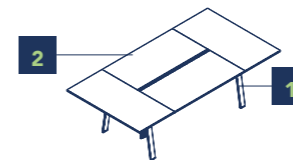

240x124 cm
h. 72 cm

Pag. 54,55

Tavolo riunione (8 posti), Meeting table (8 places), Table reunion (8 places), Besprechungstisch (8 personen), Wergadertafel (8 plaatsen), Mesa reunión (8 puestos).

1 NF

2 RT

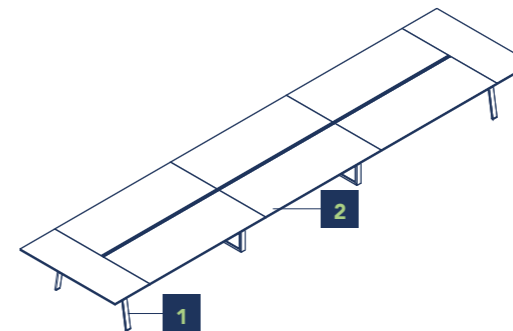

720x164 cm
h. 72 cm

Pag. 58,59,60,61

Tavolo riunione (16 posti), Meeting table (16 places), Table reunion (16 places), Besprechungstisch (16 personen), Wergadertafel (16 plaatsen), Mesa reunión (16 puestos).

1 NF

2 RT

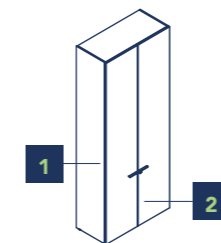

100x46 cm
h. 195 cm

Pag. 58,59,61

Armadio ABA, Cabinet ABA, Armoire ABA, Schrank ABA, Kast ABA, Armario ABA

1 MK

2 RT

desks



Scrivanìa.
Desk, Bureau, Schreibtische, Bureaus, Escritorio

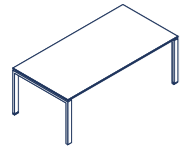

H. 72
w:80÷200 cm - d:60 cm
w:80÷200 cm - d:80 cm
w:180÷240 cm - d:100 cm

Scrivanìa a ponte per aggancio a mobile di servizio

Bridge desk for hooking to a storage unit, Bureau en pont pour fixation sur meuble de service, Schreibtisch Brückenkonstruktion zum Anhängen an Service-Möbel, Brugbureau voor vasthaking aan dienstmodule, Escritorio en puente para enganchar a mueble de servicio

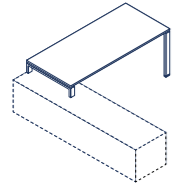

H. 72
w.160÷200 - d.80cm
w.180÷200 - d.100cm

Dattilo appeso dx=sx

Rh=Lh hanging additional desk, Dactylo suspendue ga=dr, Hängender tischmodul re=li, Opleghulptafel re=li, Escritorio colgado adicional derecho=izquierdo

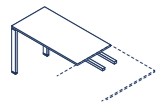

H. 72
w: 80÷200 cm - d:60cm

Scrivanìa con cassetiera portante

Desk with support pedestal, Bureau avec caissons portant, Schreibtische mit schubladenkasten, Bureaus met ladenblok, Escritorio con cajonera de sustentación.

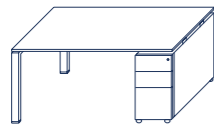

H. 72
w:120÷200 cm - d:60 cm
w:120 cm÷200 - d:80 cm

Scrivanìa con vertical file

Desk with vertical file, Bureau avec vertical file, Schreibtische mit vertical file, Bureau met vertical file, Escritorio con vertical file

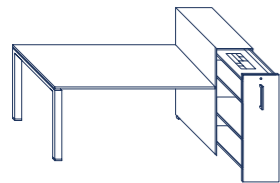

H. 72
w:140÷240 cm - d.80 cm

Posto di lavoro per 4 persone

Workstation for 4 people, Poste de travail pour 4 personnes, Arbeitsplatz für 4 personen, Werkplek voor 4 plaatsen, Puesto de trabajo para 4 personas

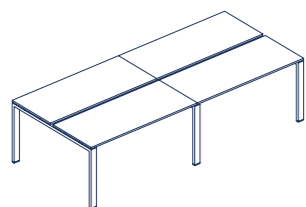

H. 72
w:240÷400 - d:124 cm
w:240÷400 - d:164 cm

Scrivanìa con gamba zoppa per aggancio al mobile di servizio

Desk with shortened leg for hooking to the storage unit, Bureau avec piétement pour fixation sur meuble de service, Schreibtisch mit verkürztem Bein zum Anhängen an Service-Möbel, Bureau met manke poot voor vasthaking aan dienstmodule, Escritorio con pata coja para enganchar al mueble de servicio

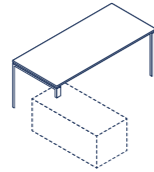

H. 72
w:160÷200 cm - d.80 cm
w:180÷200 cm - d:100cm

Scrivanìa per aggregazioni lineari

Desk for linear aggregations, Bureau pour agregations lineaires, Schreibtische für lineare verbindungen, Bureaus voor lineaire opstellingen, Escritorio para uniones lineales

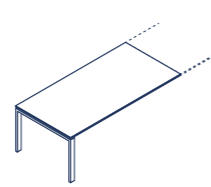

H. 72
w:80÷200 cm - d:60cm
w:80÷200 cm - d:80cm
w:180÷240 cm - d:100cm

Dattilo appeso dx=sx con cassetiera portante

Rh=Lh hanging additional desk with support pedestal, Dactylo suspendue ga=dr avec caissons portant, Hängender tischmodul re=li mit schubladenkasten, Opleghulptafel re=li met ladenblok, Escritorio colgado adicional de=iz con cajonera de sustentación

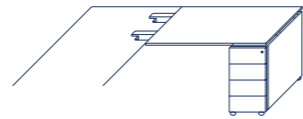

H. 72
w:100÷200 cm - d:60 cm

Scrivanìa con vertical file portante

Desk with support vertical file, Bureau avec vertical file portant, Schreibtische mit vertical file, Bureau met vertical file recht, Escritorio con vertical file de sustentación

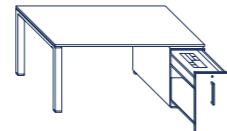

H. 72
w.100÷200 cm - d.80 cm

Posto di lavoro per 2 persone

Workstation for 2 people, Poste de travail pour 2 personnes, Arbeitsplatz für 2 personen, Werkplek voor 2 plaatsen, Puesto de trabajo para 2 personas.

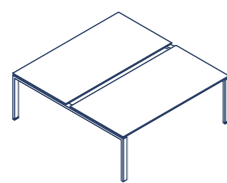

H. 72
w:120÷200 cm - d:124cm
w:120÷200 cm - d:164cm

Posto di lavoro per 6 persone

Workstation for 6 people, Poste de travail pour 6 personnes, Arbeitsplatz für 6 personen, Werkplek voor 6 plaatsen, Puesto de trabajo para 6 personas

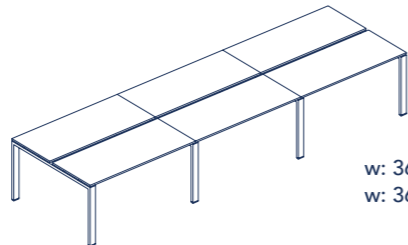

H. 72
w: 360÷600 cm - d.124 cm
w: 360÷600 cm - d.164 cm

Scrivanìa.

Desk, Bureau, Schreibtische, Bureaus, Escritorio.

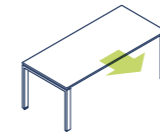

H. 72
w:140÷200 cm - d:80cm

Posto di lavoro per 4 persone

Workstation for 4 people, Poste de travail pour 4 personnes, Arbeitsplatz für 4 personen, Werkplek voor 4 plaatsen, Puesto de trabajo para 4 personas.

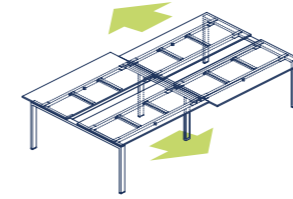

H. 72
w: 280÷400 cm - d:164cm

Tavolo H. 110

Table H. 110, Table H. 110, Tisch H. 110, Tafel H. 110, Mesa H. 110.

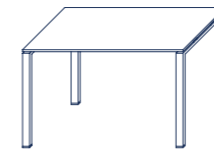

w:80 cm÷160 - d:60cm
w:100 cm÷160 - d:80cm

Tavolo rotondo con colonna

Round table with column, Table ronde avec colonne, Rundtisch mit Säule, Ronde tafel met zuil, Mesa redonda con columna.



H. 72
Ø60cm
Ø80cm
Ø100cm
Ø120cm

Tavolino

Small table, Petit table, Kleinertisch, Kleine tafel, Mesa

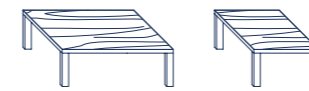

H. 40
w:60 cm - d:60 cm
w:120 cm - d:60 cm

Tavolo

Table, Table, Tisch, Tafel, Mesa

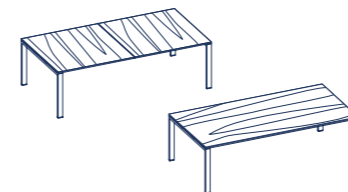

H. 72
w:240 cm - d:124cm
w:240 cm - d:124cm

Tavolo con spazzola passacavi

Table with brush element, Table avec brosse, Tisch mit bürstenelement, Tafel met borstelement, Mesa con cepillo pasacables

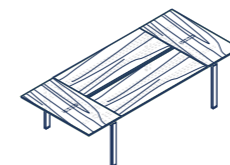

H. 72
w: 240÷320 cm - d:124cm
w: 240÷320 cm - d:164cm

Posto di lavoro per 2 persone

Workstation for 2 people, Poste de travail pour 2 personnes, Arbeitsplatz für 2 personen, Werkplek voor 2 plaatsen, Puesto de trabajo para 2 personas.

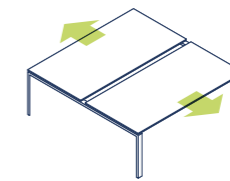

H. 72
w.:140÷200 cm - d.:164cm

Posto di lavoro per 6 persone

Workstation for 6 people, Poste de travail pour 6 personnes, Arbeitsplatz für 6 personen, Werkplek voor 6 plaatsen, Puesto de trabajo para 6 personas.

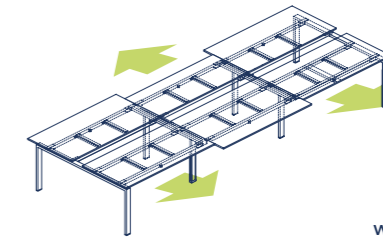

H. 72
w: 420÷600 cm - d:164 cm

Tavolo altezza regolabile

Height adjustable table, Table réglable en hauteur, Höhe verstellbaren Tisch, Hoogte verstelbare tafel, Mesa regulable en altura.



Ø80 cm - h:73÷109 cm

Tavolo rotondo

Round table, Table ronde, Runder tisch, Ronde tafel, Mesa redonda



H. 72
Ø100cm
Ø118cm

Tavolo

Table, Table, Tisch, Tafel, Mesa

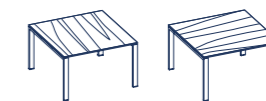

H. 72
w:124 cm - d:120 cm
w:124 cm - d:124 cm
w:164 cm - d:164 cm

Tavolo con spazzola passacavi

Table with brush element, Table avec brosse, Tisch mit bürstenelement, Tafel met borstelement, Mesa con cepillo pasacables

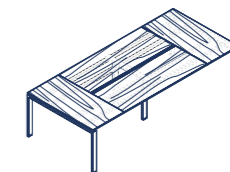

H. 72
w:280÷320 cm - d:124cm
w:280÷320 cm - d:164cm

Tavolo con spazzola passacavi

Table with brush element, Table avec brosse, Tisch mit bürstenelement, Tafel met borstelement, Mesa con cepillo pasacables

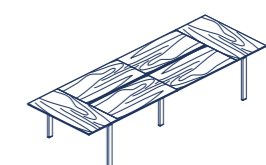

H. 72
w:360÷520 cm - d:124cm
w:360÷520 cm - d:164cm

storage

ABA

Armadi ABA, Cabinets ABA, Armoires ABA, Schranke ABA, kastenv ABA, Armarios ABA

H. 78,6

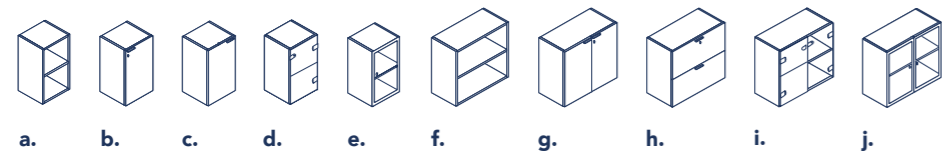

D. 36/46

- a. w:50 cm - h:78,6 cm
- b. w:50 cm - h:78,6 cm
- c. w:50 cm - h:78,6 cm
- d. w:50 cm - h:78,6 cm
- e. w:50 cm - h:78,6 cm
- f. w:80/100 cm - h:78,6 cm
- g. w:80/100 cm - h:78,6 cm
- h. w:80/100 cm - h:78,6 cm
- i. w:80/100 cm - h:78,6 cm
- j. w:80/100 cm - h:78,6 cm

H. 117

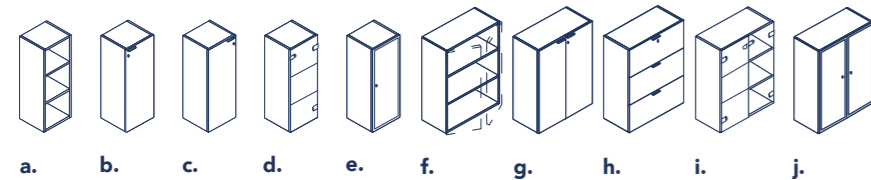

D. 36/46

- a. w:50 cm - h:117 cm
- b. w:50 cm - h:117 cm
- c. w:50 cm - h:117 cm
- d. w:50 cm - h:117 cm
- e. w:50 cm - h:117 cm
- f. w:80/100 cm - h:117 cm
- g. w:80/100 cm - h:117 cm
- h. w:80/100 cm - h:117 cm
- i. w:80/100 cm - h:117 cm
- j. w:80/100 cm - h:117 cm

H. 155,4

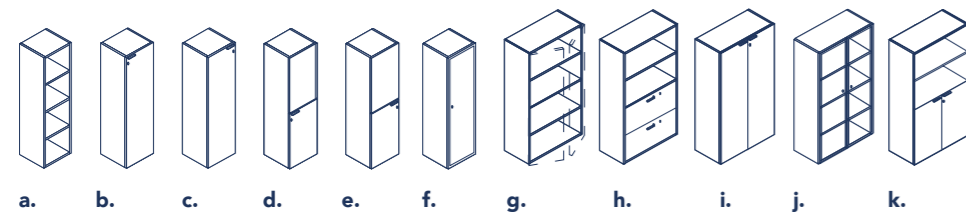

D. 36/46

- a. w:50 cm - h:155,4 cm
- b. w:50 cm - h:155,4 cm
- c. w:50 cm - h:155,4 cm
- d. w:50 cm - h:155,4 cm
- e. w:50 cm - h:155,4 cm
- f. w:50 cm - h:155,4 cm
- g. w:80/100 cm - h:155,4 cm
- h. w:80/100 cm - h:155,4 cm
- i. w:80/100 cm - h:155,4 cm
- j. w:80/100 cm - h:155,4 cm
- k. w:80/100 cm - h:155,4 cm

H. 193,8

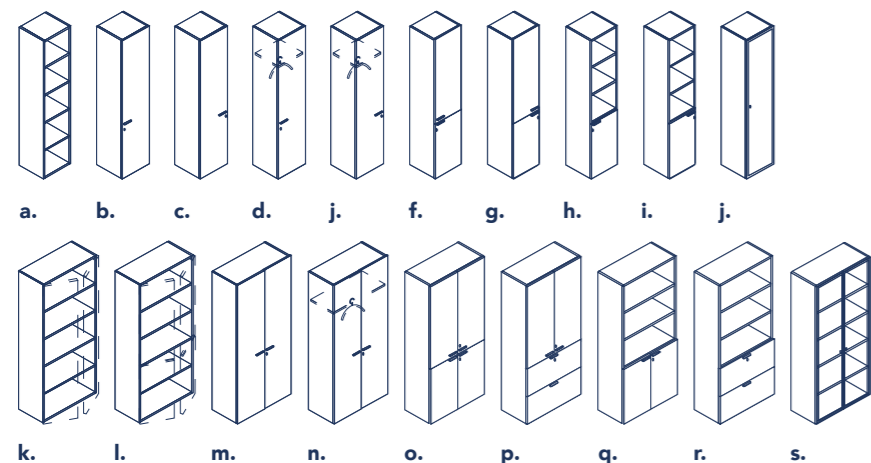

D. 36/46

- a. w:50 cm - h:193,8 cm
- b. w:50 cm - h:193,8 cm
- c. w:50 cm - h:193,8 cm
- d. w:50 cm - h:193,8 cm
- e. w:50 cm - h:193,8 cm
- f. w:50 cm - h:193,8 cm
- g. w:50 cm - h:193,8 cm
- h. w:50 cm - h:193,8 cm
- i. w:50 cm - h:193,8 cm
- j. w:50 cm - h:193,8 cm
- k. w:80/100 cm - h:193,8 cm
- l. w:80/100 cm - h:193,8 cm
- m. w:80/100 cm - h:193,8 cm
- n. w:80/100 cm - h:193,8 cm
- o. w:80/100 cm - h:193,8 cm
- p. w:80/100 cm - h:193,8 cm
- q. w:80/100 cm - h:193,8 cm
- r. w:80/100 cm - h:193,8 cm
- s. w:80/100 cm - h:193,8 cm

• NO D 36 cm
• NO W 80 cm

H. 232,2

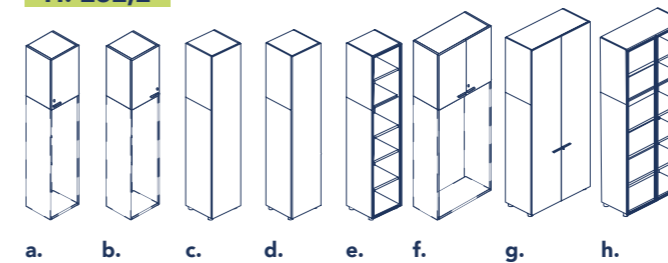

D. 36/46

- a. w:50 cm - h:232,2 cm
- b. w:50 cm - h:232,2 cm
- c. w:50 cm - h:232,2 cm
- d. w:50 cm - h:232,2 cm
- e. w:50 cm - h:232,2 cm
- f. w:80/100 cm - h:232,2 cm
- g. w:80/100 cm - h:232,2 cm
- h. w:80/100 cm - h:232,2 cm

H. 270,6

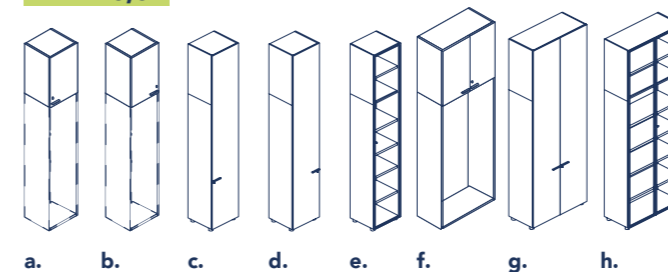

D. 36/46

- a. w:50 cm - h:270,6 cm
- b. w:50 cm - h:270,6 cm
- c. w:50 cm - h:270,6 cm
- d. w:50 cm - h:270,6 cm
- e. w:50 cm - h:270,6 cm
- f. w:80/100 cm - h:270,6 cm
- g. w:80/100 cm - h:270,6 cm
- h. w:80/100 cm - h:270,6 cm

ASL, Cabinets ASL, Armoires ASL, Schranke ASL, kasten ASL, Armarios ASL

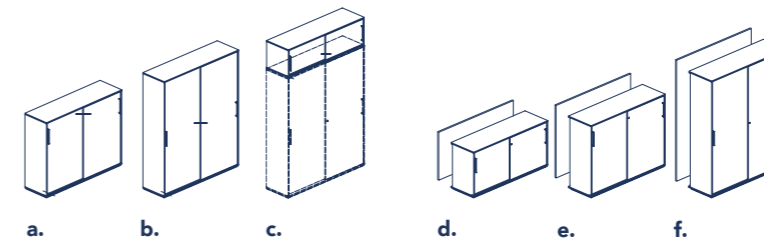

- a. w:120/160 cm - d:460 cm - h:80.6/119/157.4 cm
- b. w:120/160 cm - d:460 cm - h:195.8 cm
- c. w:120/160 cm - d:460 cm - h:53 cm
- d. w:120/160 cm - d:480 cm - h:53 cm
- e. w:120/160 cm - d:480 cm - h:80.6/119/157.4 cm
- f. w:120/160 cm - d:480 cm - h:80.6/119/157.4 cm

Cassettiere e mobili di servizio, Pedestals and service modules, Caissons et meuble de service, Holzcontainer und multifunktionscontainer, Ladeblöcke an dienstmeubels, Cajoneras y módulos de servicio

D. 56,2

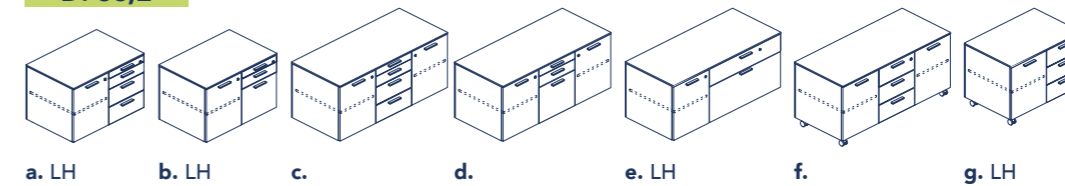

- a. w:83.6 cm - h:54 cm
- b. w:83.6 cm - h:54 cm
- c. w:125.3 cm - h:54 cm
- d. w:125.3 cm - h:54 cm
- e. w:125.3 cm - h:54 cm
- f. w:125.3 cm - h:58.5 cm
- g. w:83.6 cm - h:58.5 cm
- h. w:167.2 cm - h:54 cm
- i. w:167.2 cm - h:54 cm
- j. w:208.9 cm - h:54 cm
- k. w:208.9 cm - h:54 cm
- l. w:208.9 cm - h:54 cm

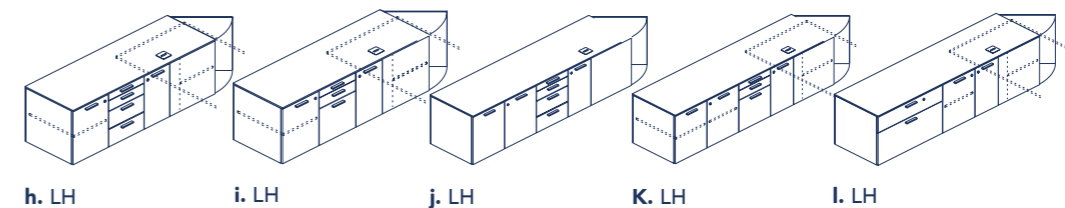

D. 46

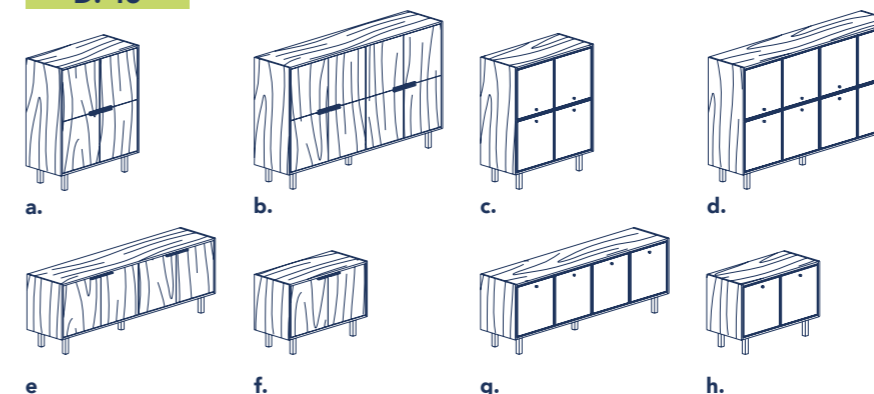

- a. w:102,4 cm - h:122,9 cm
- b. w:202,4 cm - h:122,9 cm
- c. w:102,4 cm - h:122,9 cm
- d. w:202,4 cm - h:122,9 cm
- e. w:202,4 cm - h:71,7 cm
- f. w:102,4 cm - h:71,7 cm
- g. w:202,4 cm - h:71,7 cm
- h. w:102,4 cm - h:71,7 cm

accessories

Tappo passacavi

Cable access port, Passe-câbles, Kabeldose, Kabeldoorvoerdop, Tapón pasacables.



Top access

Top access, Top-access, Top access, Toegang bovenaan, Acceso superior.

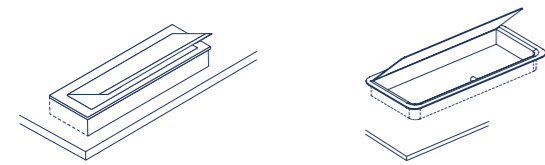

Cestelli portacavi ruotabile ed ispezionabile

Cables holder baskets rolling and inspectionable, Bac porte-cables roulant et inspectionable, Kabel halterkörbchen schwenk-und einsehbar, Draaibare en controleerbare korfjes voor elektrische bedrading, Cestos portaenchufes que se vuelta e inspeccionar.

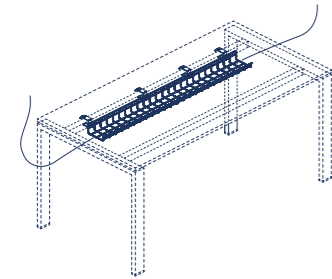

H. 7,5

w:60 cm - d:14 cm
w:120 cm - d:14 cm
w:80 cm - d:32 cm
w:120 cm - d:32 cm

Passacavi

cables-carrier, Passage de câbles, Kabeldurchlass, Draadleider, Pasacables.

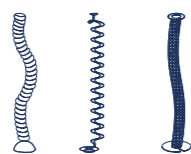
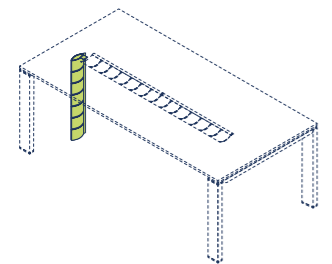

Cassetino sottocrivania

Drawer under desk, Tiroir sous le bureau, Schublade unter Schreibtisch, Lade onder desk, Cajón de debajo del escritorio.

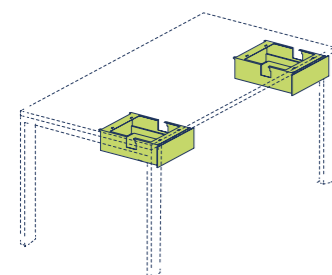

Blocco portaprese

Socket-holder, Porte-prises, Elektro-Dosenblock, Stekker, Portatomas de corriente.

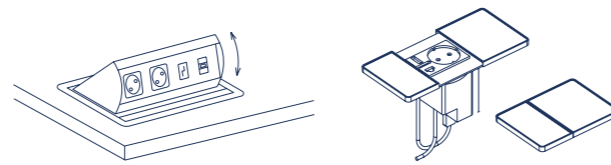

Cestelli portacavi ruotabile ed ispezionabile

Cables holder baskets rolling and inspectionable, Bac porte-cables roulant et inspectionable, Kabel halterkörbchen schwenk-und einsehbar, Draaibare en controleerbare korfjes voor elektrische bedrading, Cestos portaenchufes que se vuelta e inspeccionar.

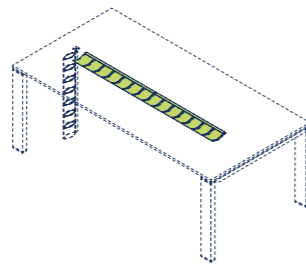

H. 4

w:65 cm - d:11 cm
w:120 cm - d:11 cm

Porta monitor con morsetto (singolo-doppio)

Monitor stand with clamp (single-double), Porte-écran avec clip (simple-double), Monitorträger mit Klemme (Einzel-Doppel), Monitorsteun met clips (single, dubbele), Para monitor con borne (individuales, dobles).

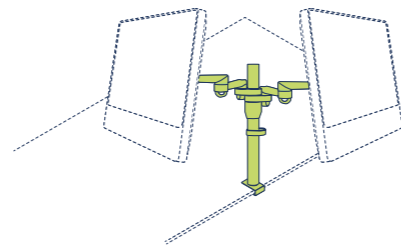

Gonna per scrivania

Modesty panel for desk, Voile de fond pour bureau, Schreibtischblende, Bureaubord, Panel para escritorio.

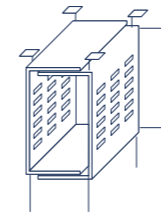
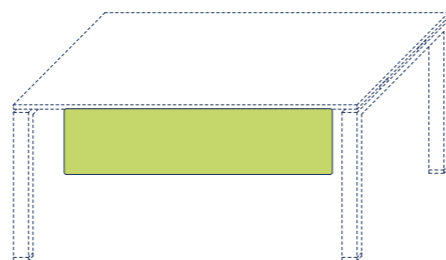

Porta cpu appeso alle travi regolabile in larghezza

Cpu stand hung from beams, width-adjustable, Porte-UC suspendu aux traverses, réglable en largeur, Breitenverstellbarer, an den Querträgern befestigter Zentraleinheitenträger, Aan de dwarsbalk hangende CPU-steun, verstellbare breedte, Porta cpu colgado en las vigas, ajustable en altura.

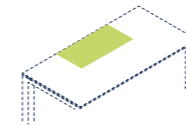

Sottomano in pelle ecologica

Imitation leather desk pad, Sous-main en peau écologique, Schreibunterlage aus kunstleder, Onderlegger in kunstleer, Vade de piel ecológica.

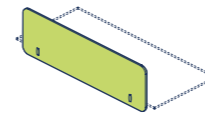

Schermo per scrivania e bench

Screen for desks and bench, Ecran privatif pour bureau et bench, Schirmwand Schreibtisch und Bench, Bureau en bench scherm, Pantalla para escritorios y bench.

w: 80÷220 cm - d:1,8 cm - h:48 cm

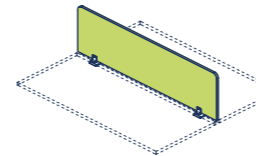

Schermo per scrivania e bench

Screen for desks and bench, Ecran privatif pour bureau et bench, Schirmwand Schreibtisch und Bench, Bureau en bench scherm, Pantalla para escritorios y bench.

w: 80÷200 cm - d:1,8 cm - h:38 cm

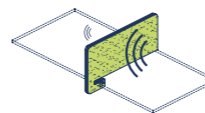

Schermo per scrivania e bench

Screen for desks and bench, Ecran privatif pour bureau et bench, Schirmwand Schreibtisch und Bench, Bureau en bench scherm, Pantalla para escritorios y bench.

w:70÷90 cm - d:4,2 cm - h:48cm

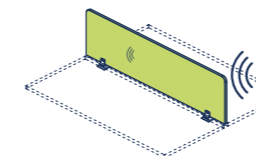

Schermo per scrivania e bench

Screen for desks and bench, Ecran privatif pour bureau et bench, Schirmwand Schreibtisch und Bench, Bureau en bench scherm, Pantalla para escritorios y bench.

w:80÷200 cm - d:4.2 cm - h:38 cm

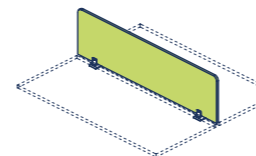

Schermo divisorio vetro

Glass screen, Écran de séparation frontale verre, Sichtschutzpaneel Glas, Stärke Glazen schermverdeling, Pantalla separadora de cristal

w: 80÷200 cm - d:0,8 cm - h:38 cm

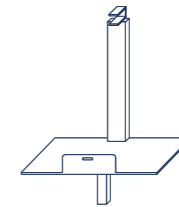

Porta cpu metallico (appeso alla gamba)

Cpu holder (suspended to the leg), Porte pour uc en metal (suspendu à la jambe), Metall-towerhalter (auf Lenkrollen), Metalen cpu-houder (opgeschoort aan het been), Porta cpu metálico (colgado a la pata).

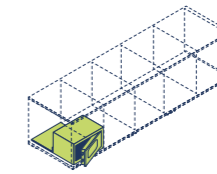

Cassaforte da incasso con staffa di bloccaggio

Built-in safe for service cabinets, Coffre-fort à encastrier pour meubles de service, Einbau-Safe für Service-Möbel, Inbouwbrandkast voor dienstmodules, Caja fuerte empotrada para mueble de servi.

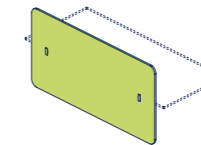

Schermo per scrivania e bench

Screen for desks and bench, Ecran privatif pour bureau et bench, Schirmwand Schreibtisch und Bench, Bureau en bench scherm, Pantalla para escritorios y bench.

w:80÷220 cm - d:1,8 cm - h:82,3 cm

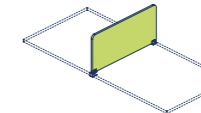

Schermo per scrivania e bench

Screen for desks and bench, Ecran privatif pour bureau et bench, Schirmwand Schreibtisch und Bench, Bureau en bench scherm, Pantalla para escritorios y bench.

w:60+80 cm - d:1,8 cm - h:38 cm

Sistemi per il passaggio cavi e per l'elettrificazione dei piani

Cable holding and top electrification systems, Systèmes passe-câbles et pour l'électrification des plateaux, Systeme für Kabeldurchlass und Elektrifizierung der Tischplatten, Kabeldoorvoersystemen en bekabelingssystemen van de bladen, Sistemas para el paso de los cables y para la electrificación de los sobres

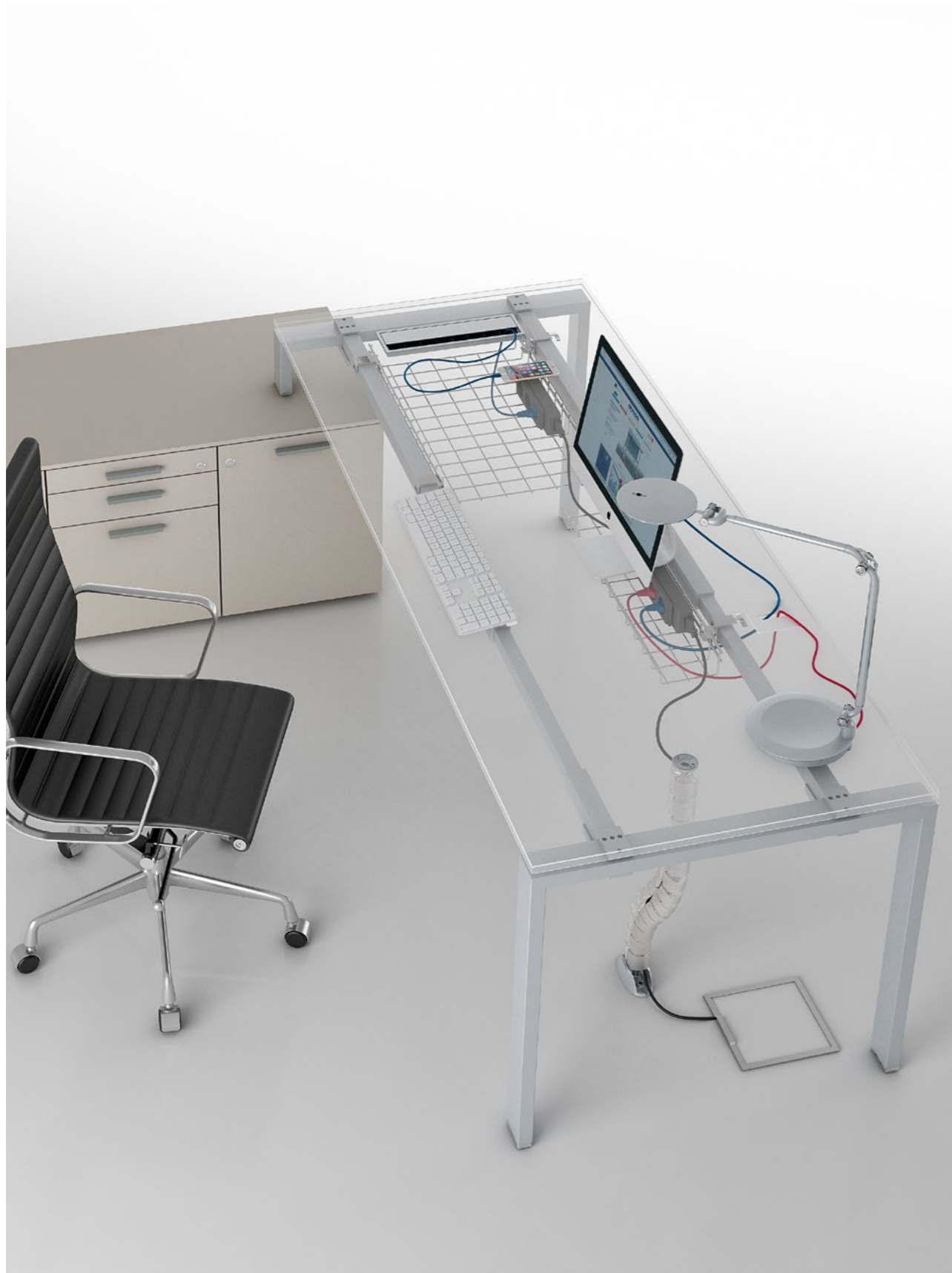

finiture

finishes, finitions, Oberflächen, afwerkingen, acabados

laccato opaco,

matt lacquered, lacqué matt, lacqué mat, matt lackiert, matgelakt, laqueado mate

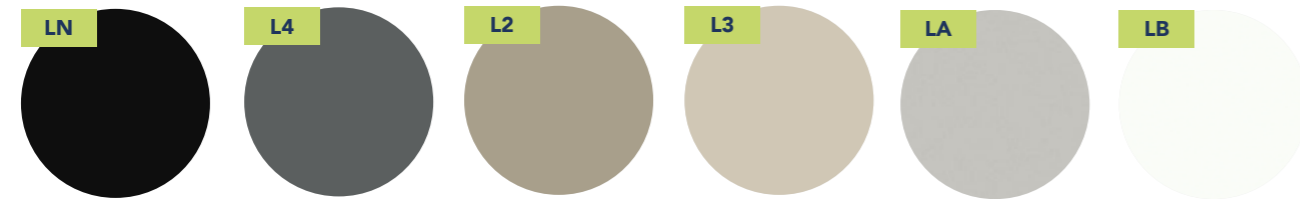

LN
nero
black
noir
schwarz
zwart
negro

L4
titanio
titanium
titane
titan
titanium
titanio

L2
tortora
turtledove
tourterelle
turteltaube
tortelduif
tòrtola

L3
nebbia
mist
brouillard
Nebelgrau
mist
niebla

LA
alluminio
aluminium
aluminium
aluminium
aluminium
aluminio

LB
bianco
white
blanc
weiß
wit
bianco

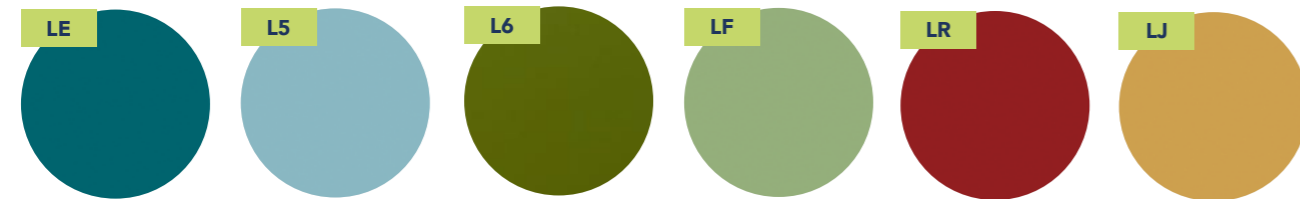

LE
deep teal
deep teal
bleu canard
deep teal
deep teal
deep teal

L5
oceano
ocean
océan
meerblau
ocean
oceano

L6
verde muschio
moss green
vert mousse
moosgrün
mosgroen
verde musgo

LF
verde natura
gras green
vert nature
grasgrün
groene natuur
verde naturaleza

LR
bordeaux
bordeaux
bordeaux
bordeaux
bordeaux
burdeos

LJ
giallo gold
yellow gold
jaune or
goldgelb
geelgouden
oro amarillo

vetroceramica,

glass ceramic, vitroceramique, glaskeramik, vitrokeramisch, vitroceramica



EK
Nero marquina opaco
Marquina black matt
Noir mat marquina
Schwarz matt marquina
Zwart marquina mat
Marquina negro mate

EB
Bianco calacatta lucido
Glossy white calacatta
Blanc brillant calacatta
Weiß glänzend calacatta
Glänzend wit calacatta
Calacatta blanco brillo

EG
Grigio stone opaco
Stone grey matt
Gris mat stone
Grau matt stone
Grijs stone mat
Gris mate stone

Vetro temperato,

tempered glass, verre trempé, Temperiertes Glas, gehard glas, vidrio templado

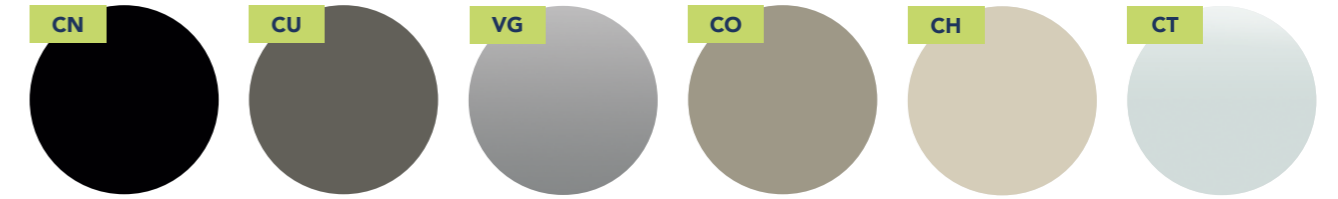

CN
nero
black
noir
Schwarz
zwart
negro

CU
titanio
titanium
titane
Titan
titanium
titanio

VG
grigio sp. 5mm
grey sp. 5 mm
gris sp. 5 mm
Grau sp. 5 mm
grijs sp. 5 mm
gris sp. 5 mm

CO
tortora
turtledove
tourterelle
Turteltaube
tortelduif
tòrtola

CH
nebbia
mist
brouillard
Nebelgrau
mist
niebla

CT
satinato
frosted
satiné
mattier
gesatineers
satinado



CK
trasparente
transparent
transparent
transparentes
transparente
transparente

CB
bianco
white
blanc
Weiß
wit
blanco

vetro temperato opaco,

tempered matt glass, verre trempé opaque, Matt temperiertes Glas, mat gehard glas, vidrio templado mate

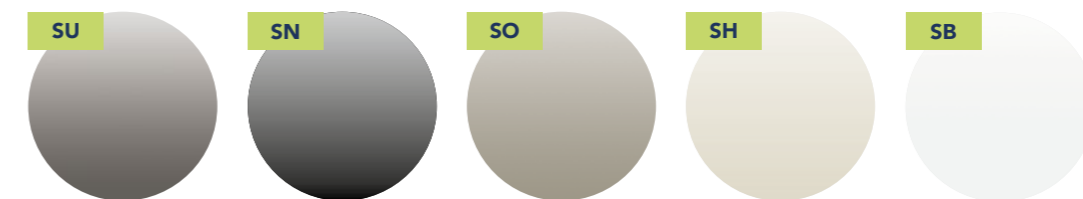

SU
titanio
titanium
titane
titan
titanium
titanio

SN
nero
black
noir
Schwarz
zwart
negro

SO
tortora
turtledove
tourterelle
turteltaube
tortelduif
tòrtola

SH
nebbia
mist
brouillard
Nebelgrau
mist
niebla

SB
bianco
white
blanc
Weiß
wit
blanco

tessuto,

fabric, tissu, stoffe, stof, tejido

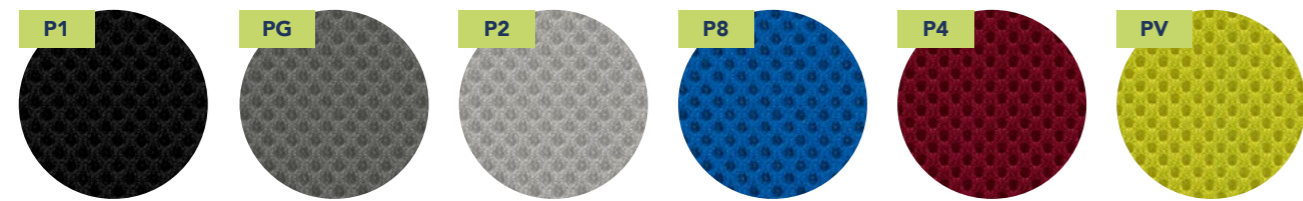

P1
PUMA nero
black
noir
schwarz
zwart
negro

PG
PUMA grigio scuro
dark grey
gris foncé
dunkelgrau
gewoon grijs
gris hormigón

P2
PUMA grigio medio
medium grey
gris moyen
mittelgrau
gewoon grijs
gris hormigón

P8
PUMA blu
dark blue
bleu
blau
blauw
azul

P4
PUMA bordeaux
bordeaux
bordeaux
bordeaux
bordeaux
burdeos

PV
PUMA verde mela
apple green
vert pomme
apfelgrün
applegroen
verde manzana

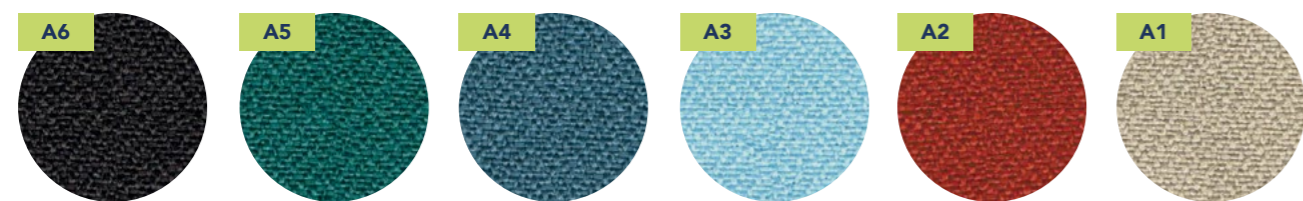

A6
CAMIRA-LUCIA testa di moro-sombrero
dark brown-sombrero
brun gris-sombrero
dunkelbraun-sombrero
donkerbruin-sombrero
pardo grisáceo-sombrero

A5
CAMIRA-LUCIA petrolio-windjammer
petroleum-windjammer
pétrole-windjammer
ptroleum blau-windjammer
petrolium-windjammer
petróleo-windjammer

A4
CAMIRA-LUCIA blu-martinique
blue-martinique
bleu-martinique
blau-martinique
blauw-martinique
azul-martinique

A3
CAMIRA-LUCIA celeste-arecibo
light blue-arecibo
bleu-arecibo
hellblau-arecibo
hemelsblau-arecibo
azul celeste-arecibo

A2
CAMIRA-LUCIA mattone-jamaica
brick-coloured jamaica
brique-jamaica
ziegelrot-jamaica
baksteen-jamaica
pardo cobre-jamaica

A1
CAMIRA-LUCIA sabbia-aruba
sable-aruba
sable-aruba
sandfarbe
zand-aruba
arena-aruba

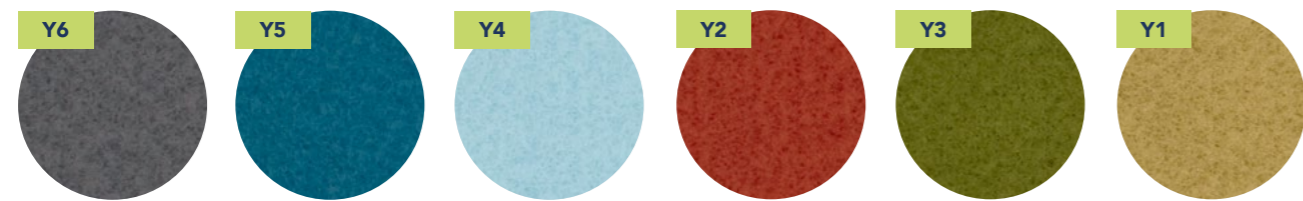

Y6
GABRIEL-STAY grigio Londra
london grey
gris Londres
london grau
london-grijs
gris Londres

Y5
GABRIEL-STAY blu avio
air force blue
blue aviation
avio blau
avio-blauw
azul colombino

Y4
GABRIEL-STAY celeste
light blue
bleu
hellblau
hemelsblauw
azul celeste

Y2
GABRIEL-STAY arancio
orange
orange
orange
orange
naranja

Y3
GABRIEL-STAY verde
green
vert
grün
groen
verde

Y1
GABRIEL-STAY giallo
yellow
jaune
gelb
geel
amarillo



X2
GABRIEL-XPRESS verde sottobosco
underwood green
vert sous-bois
unterholz-groen
bosgrond-groen
verdes-sottobosque

X3
GABRIEL-XPRESS blue jeans
blue jeans
bleu jeans
denim blue
jeans blauw
azul denim

X1
GABRIEL-XPRESS giallo primavera
spring yellow
jaune printemps
frühling gelb
lentegeel
amarillo primavera

parti metalliche,

metal structure, structure métallique, metalstruktur, stalen constructie, estructura metálicas

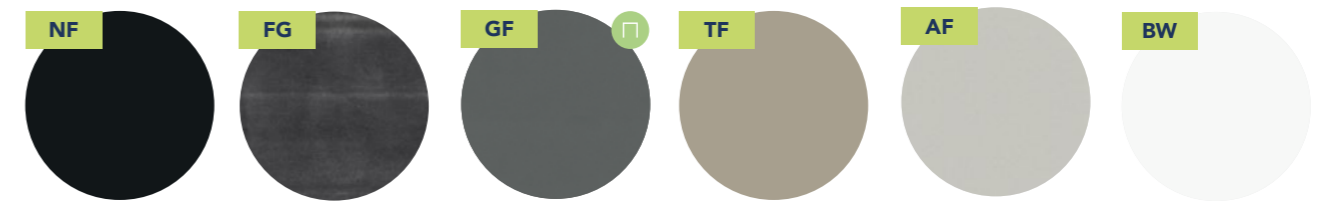

NF
nero
black
noir
schwarz
zwart
negro

FG
metallo crudo
raw metal
métal brut
rohes metall
onbehandeld metaal
metal toscó

GF
grigio granito
granite grey
gris granit
granitgrau
granietgrijs
gris granito

TF
tortora
turtledove
tourterelle
turteltaube
tortelduif
törtola

AF
epox alluminio
silver epoxy
epoxy aluminium
aluminium
aluminiumkler geepoxerd
epoxidica de aluminio

BW
bianco
white
blanc
weiß
wit
blanco



KR
cromo lucido
glossy chrome
chrome brillant
chrom poliert
glazend verchromd
cromo pulido

MN
nero opaco
black matt
noir mat
schwarz matt
zwart mat
negro mate

MG
grigio
grey
gris
grau
grijs
gris

MB
bianco opaco
white matt
blanc mat
weiss matt
wit mat
brillo mate

metacrilato,

methacrylate, méthacrylate, methacrylat, methacrylaat, metacrilato

Fenix,

Fenix, Fenix, Fenix, Fenix, Fenix



HG
titanio 724
titanium 724
titane 724
titan 724
titanium 724
titanio 724

HA
acciaio hamilton
hamilton steel
acier hamilton
hamilton stahl
hamilton staal
acero hamilton

HO
bianco
white
blanc
weiß
wit
blanco

NE
particolari colore nero
black-painted particular items
détails en noir
details farbe schwarz
details in zwarte kleur
detalles de color negro

AP
particolari colore alluminio
silver-painted particular items
détails en aluminium
details farbe aluminium
details in aluminium kleur
detalles de color aluminio

BP
particolari colore bianco
white-painted particular items
détails en blanc
details farbe weiß
details in wit kleur
detalles de color blanco

plastica,

plastic, plastique, plastik, plastic, plástico

melaminico,

melamine, mélamine, melamin, melamine, melamina



nero
black, noir, Schwarz, zwart, negro

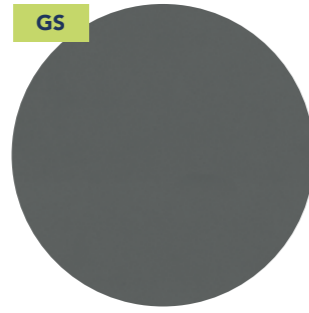

Grigio granito
Granite grey, Gris granit, Granitgrau
Grانيتgrijs, Gris granito

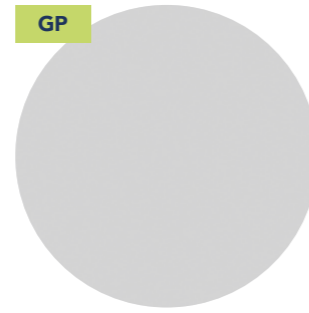

grigio perla
pearl grey, gris perle, perlgrau, parelgrijs,
gris perla

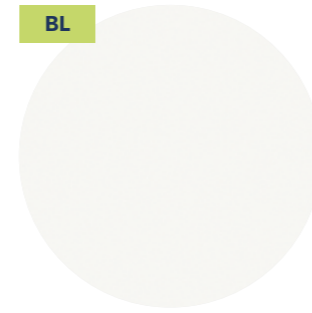

bianco
white, blanc, Weiß, wit, bianco

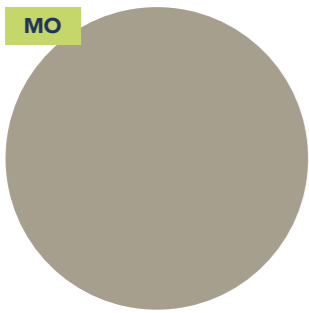

tortora
turtledove, tourterelle, Turteltaube,
tortelduif, tørtola

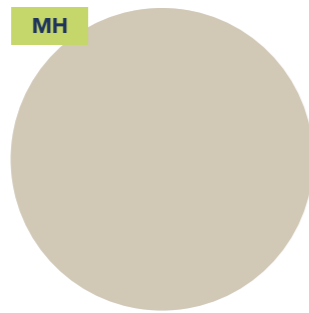

nebbia
mist, brouillard, Nebelgrau, mist, niebla



wengè
wengè, wengè, Wengè, wengè , wengè



noce canaletto
canaletto walnut, noyer canaletto,
Canaletto nussbaum, notenhout canaletto,
nogal canaletto



rovere naturale
natural oak, chêne naturel, Nature eiche,
eikenhout natuur, roble natural



rovere anticato
traditional oak, chêne antique, Eiche antik,
oud eiken decormelamine, melamina
roble antiguo



Acero champagne
Champagne hard maple,
Érable champagne, Champagner-ahorn,
Esdoorn champagne, Arce champán

Legno,

wood, bois, holz, hout, madera

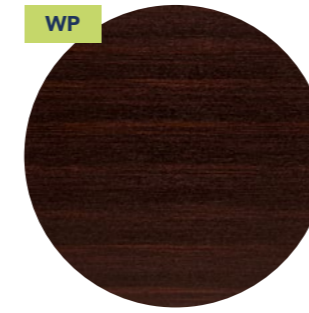

Wengè
Wengé, Wengé, Wengé, Wengé,
Wengé

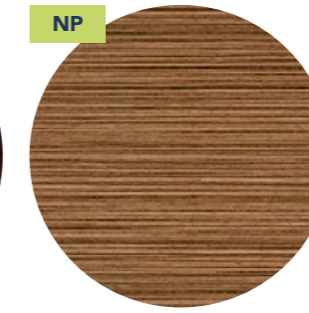

Noce americano
American walnut, Noyer américain,
Amerikanischer Nussbaum,
Amerikaans notenhout, Nogal americano

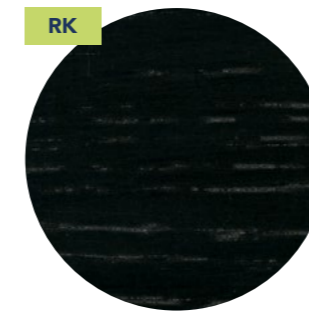

Rovere laccato nero
Black lacquered oak, Chêne laqué noir
Schwarz lackierter Eiche, Zwart gelakt
eiken, Roble lacado negro



Rovere tabacco
Tobacco oak, Chêne tabac, Eiche Tabak
Eikenhout tabak, Roble tabaco

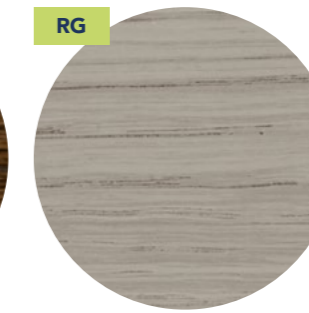

Rovere grigio
Grey oak, Chêne gris, Eiche grau,
Grijs eiken, Roble gris

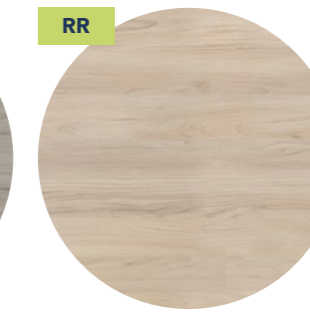

Rovere naturale
Natural oak, Chêne naturel, Natur Eiche
Eikenhout natuur, Roble natural



Rovere laccato bianco
White lacquered oak, Chêne laqué blanc,
Weiß lackierter Eiche, Wit gelakt eiken,
Roble lacado blanco

Edizione Ottobre 2018 - Particolari tecnici ed estetici possono essere modificati senza preavviso. Le rese cromatiche non sono vincolanti così come la fedeltà della riproduzione. Dati, misure e dettagli devono essere verificati con il listino.

October 2018 edition - Technical and aesthetic details can be modified without notice. Colour rendering may differ. Check the data, measures and details on the price list.

Édition Octobre 2018 - Les détails techniques et esthétiques peuvent être modifiés sans préavis. Le rendu chromatique n'est pas contractuel, ainsi que la fidélité de la reproduction. Les données, les mesures et les détails doivent être vérifiés avec le tarif.

Ausgabe Oktober 2018 - Technische und ästhetische Details könnten ohne Vorankündigung geändert werden. Die Echtheit der Farbwiedergabe ist nicht verbindlich. Daten, Maße und Details sind in der Preisliste zu überprüfen.

Uitgave Oktober 2018 - Technische en esthetische details kunnen zonder voorafgaande kennisgeving gewijzigd worden. De kleuren zijn niet bindend, net als de nauwkeurigheid van de reproductie. Gegevens, afmetingen en details moeten gecontroleerd worden met de lijst.

Edición de octubre de 2018 - Los detalles técnicos y estéticos pueden ser modificados sin preaviso. Los rendimientos de color y la fidelidad de la reproducción no son vinculantes. Los datos, las medidas y los detalles deben ser verificados con la tarifa.

BRALCO
YOUR SMART ITALIAN OFFICE

GLT

progetto: gherardi architetti
immagini: hed digital
stampa: grafiche antiga

Bralco - Via Luigi Einaudi 1, 31058 Susegana TV
T +39 0438 437 711 - F +39 0438 437 730
info@bralco.it - www.bralco.it



