

domomag

design_Fornaciari & Fait

system

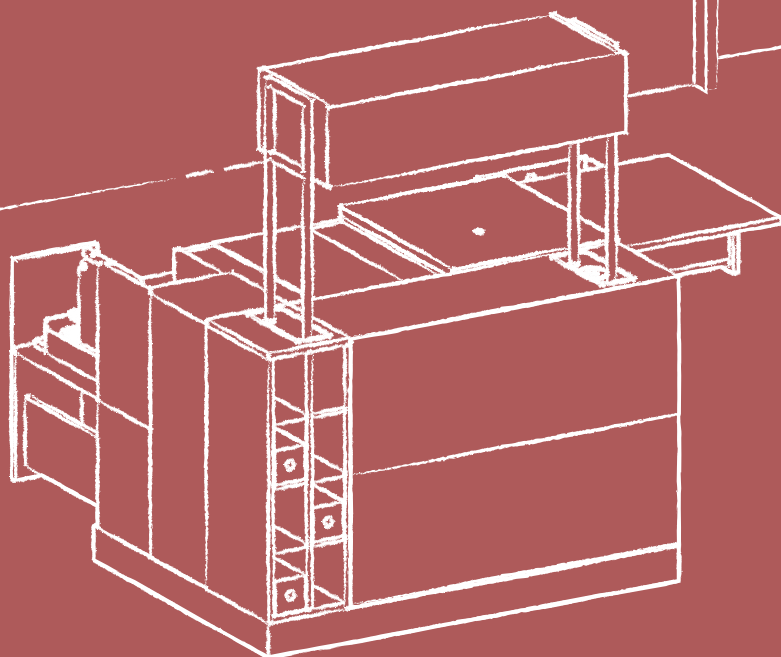
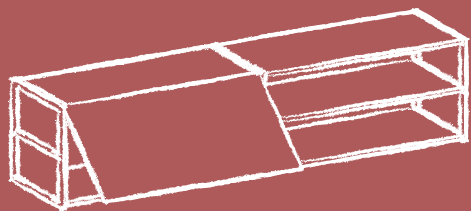

BRALCO
YOUR SMART ITALIAN OFFICE

domomag

design_Fornaciari & Fait

system

I VALORI DI DOMOMAG - The Domomag Values - Les Valeurs De Domomag - Die Werte Von Domomag - De Domomag Waarden - Los Valores De Domomag



COMPLETA
COMPLETE - COMPLÈTE
VOLLSTÄNDIG - COMPLEET
COMPLETA



CONFIGURABLE
CONFIGURABLE - CONFIGURABLE
KONFIGURIERBAR - CONFIGUREERBAAR
CONFIGURABLE

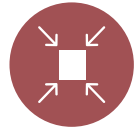

COMPATTA
COMPACT - COMPACTE
KOMPAKT - COMPACT
COMPACTA



MOBILE E RIPOSIZIONABILE
MOBILE AND REPOSITIONABLE
DEPLAÇABLE ET RECONFIGURABLE
MOBIL UND REPOSITIONIERBAR
MOBIEL EN HER-POSITIONEERBAAR
MOVIBLE Y RECOLOCABLE



COMPLETAMENTE ELETTRIFICATA
COMPLETE WITH ELECTRIFICATION
ENTIÈREMENT ÉLECTRIFIÉE
VOLLSTÄNDIG ELEKTRIFIZIERT
VOLLEDIG GEËLEKTRIFICIERT
COMPLETAMENTE ELECTRIFICADA

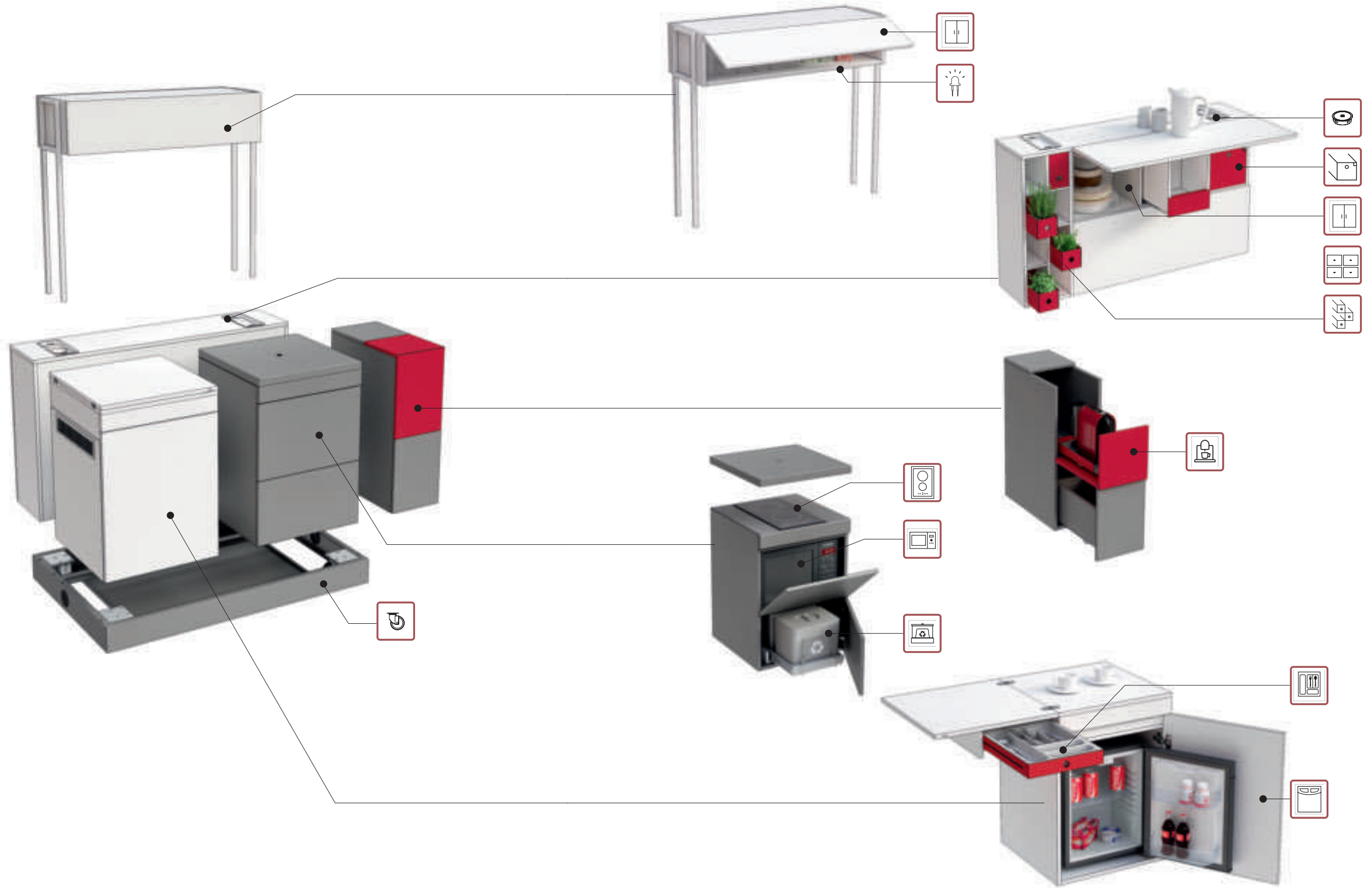

**Composizioni Domomag, su ruote - Compositions on castors - Compositions sur roulettes -
Kompositionen auf Rollen - Vrijrijbare compositie - Composiciones sobre ruedas**

DU.0805.2A

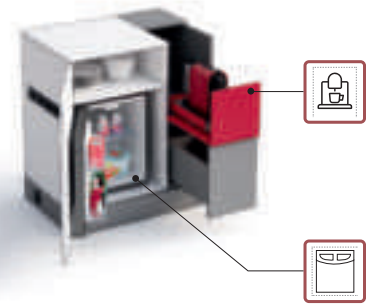

DU.0805.2B

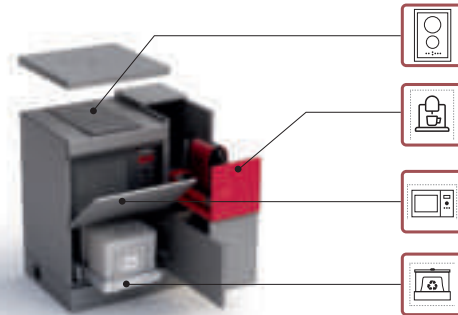

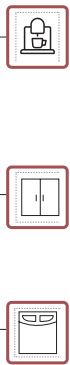
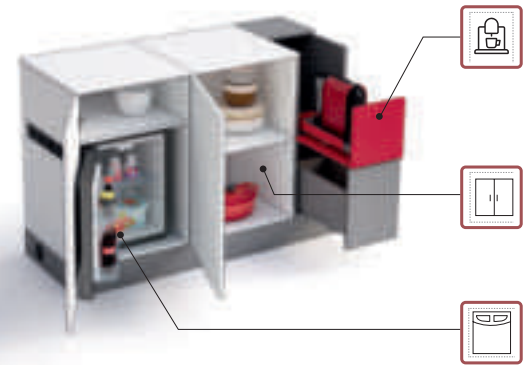

DU.1305.3A

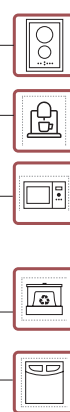

DU.1305.3B





 **Vano predisposto per macchinetta caffè**
Compartment To accommodate a coffee machine
Niche avec predisposition pour machine à café
Kaffeemaschinenfach
Compartment voor plaatsing koffiemachine
Hueco predispuosto para maquina de café

 **Vano predisposto per piano cottura**
Compartment to accommodate installation of an electric Hob
Niche avec predisposition pour plaque de cuisson
Platte mit Aufnahme für Kochfelder
Compartment voor plaatsing kookplaat
Orificio predispuosto para placa de cocción

 **2 contenitori porta rifiuti compresi**
Two waste pipes included
2 rangements pour déchets inclus
2 Abfallbehälter inklusive
2 afvalbakken inbegrepen
2 recipientes para residuos incluidos

 **Vano predisposto per frigo**
Compartment To accommodate a refrigerator
Niche avec predisposition pour frigo
Kühlschrank-Einbaufach
Compartment voor plaatsing koelkast
Cavidad predispuosta para frigorífico

 **Vano predisposto per microonde**
Compartment to accommodate a Microwave
Niche avec predisposition pour four à micro-ondes
Mikrowellen-Einbaufach
Compartment voor plaatsing magnetron
Abertura para horno de microondas

 **Cassetto portaposate compreso**
Drawer For cutlery included
Tiroir pour couverts inclus
Besteckensatz inklusive
Besteklade inbegrepen
Cajón portacubiertos incluido

 **Vano per dispensa**
Pantry Compartment
Niche pour garde-manger
Vorrätfach
Pantry compartment
Cavidad para dispensa

 **3 cassetini porta spezie compresi**
3 holding spices drawers included
3 tiroirs porte épices inclus
Inklusive 3 Mini-Schübe
3 kleine kruidenladen inbegrepen
3 cajones porta especias incluidos

DU.1308.5A

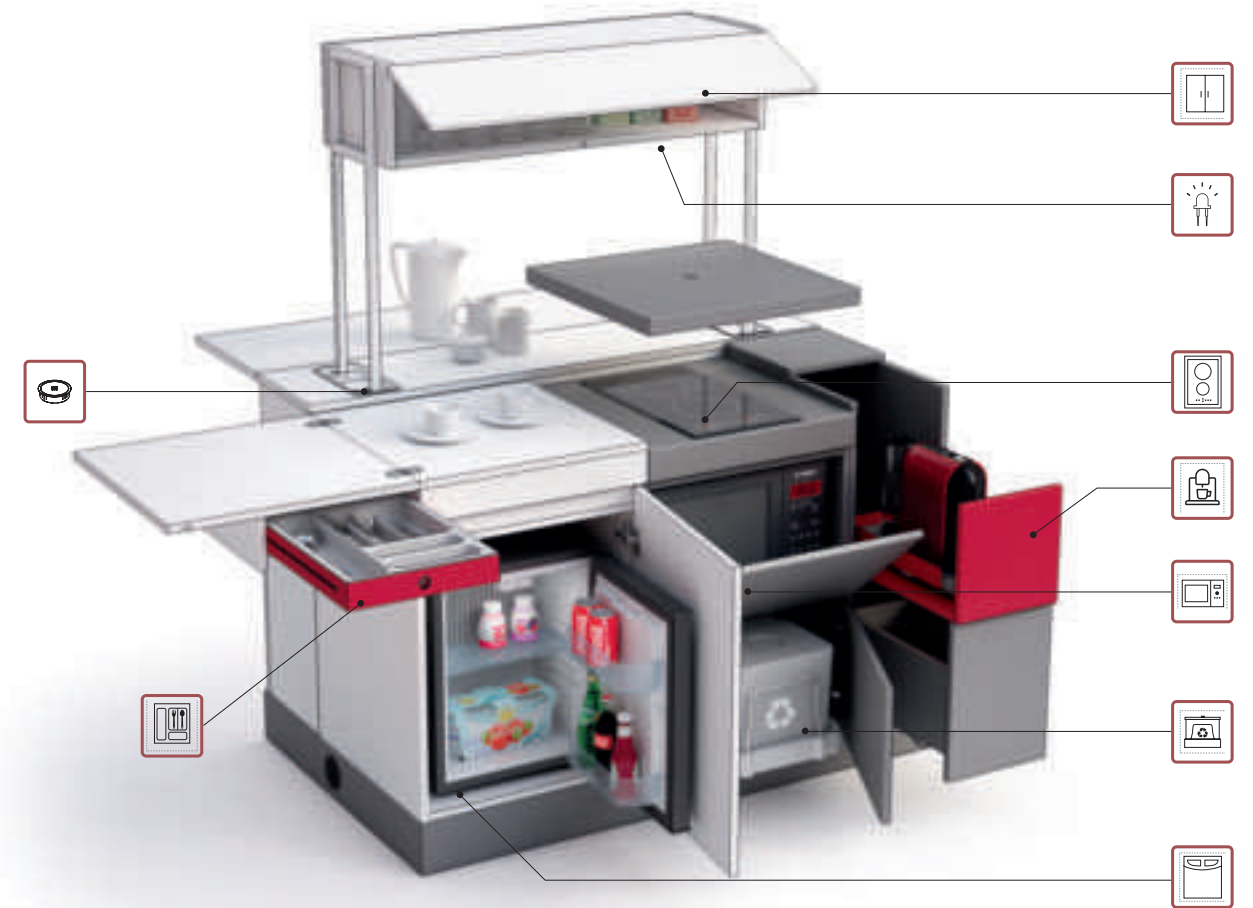

 **Optional: Versacharger**
Optional: wireless charger
Option: chargeur sans fil
Optional: Wireless-ladegerät
Optioneel: draadloze lader
Optional: Versacharger (cargador wireless)

 **Ruote**
Castors
Roulettes
Laufrollen
Wielen
Ruedas

 **Led compreso**
Led light included
Led inclus
Inklusive LED-Beleuchtung
LED licht inbegrepen
Led incluido

 **Vano tecnico ispezionabile**
Inspectionable technical compartment
Niche technique inspectionnable
Inspezierbares Kabellfach
Inspezieerbaar technisch element
Vano tecnico inspeccionable

 **4 mini contenitori**
4 small compartments
4 petits rangements
4 kleine Leerablagefächer
4 smalle elementen
4 mini contenedores

MODULI COMPONENTI, SU PIEDINI - Modular storage, on feet - Modules intégrés avec pieds
Einbaumodule, auf Rollen - Modulair opbergstysteem, op voetjes - Modulos componibles, sobre patas





 **Vano predisposto per macchinetta caffè**
Compartment To accommodate a coffee machine
Niche avec predisposition pour machine à café
Kaffeemaschinentach
Compartment voor plaatsing koffiemachine
Hueco predispuerto para maquina de café

 **Vano predisposto per piano cottura**
Compartment to accommodate installation of an electric Hob
Niche avec predisposition pour plaque de cuisson
Platte mit Aufnahme für Kochfelder
Compartment voor plaatsing kookplaat
Orificio predispuerto para placa de cocción

 **2 contenitori porta rifiuti compresi**
Two waste pipes included
2 rangements pour déchets inclus
2 Abfallbehälter inklusive
2 afvalbakken inbegrepen
2 recipientes para residuos incluidos

 **Vano predisposto per frigo**
Compartment To accommodate a refrigerator
Niche avec predisposition pour frigo
Kühlschrank-Einbaufach
Compartment voor plaatsing koelkast
Cavidad predispuerta para frigorífico

 **Vano predisposto per microonde**
Compartment to accommodate a Microwave
Niche avec predisposition pour four à micro-ondes
Mikrowellen-Einbaufach
Compartment voor plaatsing magnetron
Abertura para horno de microondas

 **Cassetino portaposate compreso**
Drawer For cutlery included
Tiroir pour couverts inclus
Besteckensatz inklusive
Besteklade inbegrepen
Cajón portacubiertos incluido

 **Vano per dispensa**
Pantry Compartment
Niche pour garde-manger
Vorrätetach
Pantry compartment
Cavidad para dispensa

 **Fondo salvagoccia compreso**
Water plate protection included
Plaque de protection projections d'eau
Inklusive Nässechutzverkleidung aus Metall
Spatwater plaat inbegrepen
Fondo salvagata incluido

 **3 cassetini porta spezie compresi**
3 holding spices drawers included
3 tiroirs porte épices inclus
Inklusive 3 Mini-Schübe
3 kleine kruidenladen inbegrepen
3 cajones porta especias incluidos



 **Pensile con possibilità di inserimento scolapiatti**
Wall unit with optional dish rack
Meuble suspendu avec égouttoir optionnel
Hängeschrank mit Einbaumöglichkeit eines Abtropfgitters
Wand met optioneel borderek
Pénsil con posibilidad de inserción de escurrer platos

 **Lavello + sifone + miscelatore monocomando compresi**
Sink Complete with Plughole and water taps included
Evier+siphon+mitigeur inclus
Inklusive Spülbecken mit Siphon und Einhebelmischbatterie
Wasbak compleet met kraan en afvoer inbegrepen
Fregadero + sifón + mezclador monomando incluidos

 **4 mini contenitori**
4 small compartments
4 petits rangements
4 kleine Leerablagefächer
4 smalle elementen
4 mini contenedores

DU.1305.3B



DU.1305.3B



DU.1308.5A



DU.1308.5A



DK.2405.C3 - DF.2017.SC

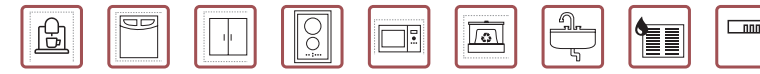



Composizioni su ruote - Compositions on castors - Compositions sur roulettes - Kompositionen auf Rollen - Vrijrijdbare compositie - Composiciones sobre ruedas

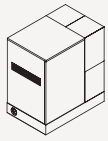

81 x 54 H.92 cm
31¾" x 21¼" H.36¼"

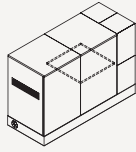
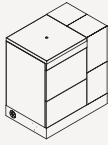

135 x 54 H.92 cm
53" x 21¼" H.36¼"

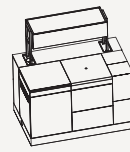
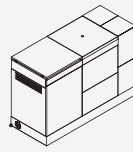

135 x 83,5 H.170 cm
53" x 32¾" H.67"

Moduli componibili, su piedini - Modular storage, on feet - Modules intégrés avec pieds - Einbaumodule, auf Rollen - Modulair opbergsysteem, op voetjes - Modulos componibles, sobre patas

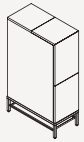

27 x 54 H.92 cm
10¾" x 21¼" H.36¼"



54 x 54 H.92 cm
21¼" x 21¼" H.36¼"

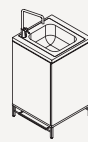

54 x 54 H.106 cm
21¼" x 21¼" H.41¾"

Scaffale e pensili - Shelf and wall unit - Étagère et meuble suspendu - Regal und Wandmodul - Plank met opknooping - Estantería y armario de pared

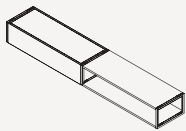

202 x 36 H.23 cm
79½" x 14" H.9"

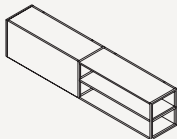

202 x 36 H.44 cm
79½" x 14" H.17¼"



202 x 36 H.170 cm
79½" x 14" H.67"

project & graphic design
marketing Bralco

3d rendered images
virtuuld.it

separation & print
graficheantiga.it

edizione giugno 2018
7MIDEDOMO02

Bralco s.r.l.
Via Luigi Einaudi, 1
31058 Susegana - TV - ITALY
T +39 0438 43 77 11
F +39 0438 43 77 30

info@bralco.it
www.bralco.it

_Particolari tecnici, estetici, finiture o altro possono essere modificati senza preavviso.

_Product details, aesthetics, finishes or other data may be subject to change without notice.

_Les détails de produit, l'esthétique, les finitions ou d'autres données peuvent être sujets au changement sans communication préalable.



_Produktdetails, Ästhetik, Ende oder andere Daten können abhängig von Änderung ohne Nachricht sein.

_De details van het product, esthetica, eindigt of andere gegevens kunnen zonder bericht voor wijzigingen vatbaar zijn.

_Los detalles del producto, la estética, los finales u otros datos pueden estar conforme a cambio sin el aviso.

Finiture - Finishes - Finitions - Oberflächen - Afwerkingen - Acabados

Melaminico - Laminate - Mélamine - Melamin - Melamine - Melamina

G5	RD	BL
		
Grigio granito Granite grey Grís granit Granitgrau Granitgrün Grís granito	Rosso rubino Ruby red Rouge rubis Rubinrot Rubinrot Rojo rubí	Bianco White Blanc Weiß Weiß Blanco

Parti metalliche - Metal structure - Structure metallique - Metallstruktur - Stalen constructie - Estructura metalicas

GF	BW	KR	RF	AX
				
Grigio granito Granite grey Grís granit Granitgrau Granitgrün Grís granito	Bianco White Blanc Weiß Weiß Blanco	Cromo lucido Glossy Chrome Chromé brillant Chrom Polier Glänzend Verchromt Cromo Pulido	Rosso rubino Ruby red Rouge rubis Rubinrot Rubinrot Rojo rubí	Acciaio Inox Stainless steel Acier inoxydable Edelstahl Roestvrij staal Acero inoxidable

Plastic - Plastic - Plastique - Plastik - Plastic - Plastico

BP	NE
	
Particolari colore bianco Whitepainted particular items Détails en blanc Details farbe weiss Details in wit kleur Detalles de color blanco	Particolari colore nero Blackpainted particular items Détails en noir Details farbe schwarz Details in zwart kleur Detalles de color negro

